

## IGBT MODULE ( F series)

### ■ Features

- Low Saturation Voltage
- Voltage Drive
- Variety of Power Capacity Series

### ■ Applications

- Inverter for Motor Drive
- AC and DC Servo Drive Amplifier
- Uninterruptible Power Supply
- Industrial Machines, such as Welding Machines

### ■ Maximum Ratings and Characteristics

#### ● Absolute Maximum Ratings

Items	Symbols	Ratings	Units
Collector-Emitter Voltage	V <sub>CEs</sub>	1200	V
Gate-Emitter Voltage	V <sub>GES</sub>	±20	V
Collector Current	Continuous	I <sub>C</sub>	300
	1ms	I <sub>C pulse</sub>	600
	Continuous	-I <sub>C</sub>	300
	1ms	-I <sub>C pulse</sub>	600
Max. Power Dissipation	P <sub>C</sub>	1800	W
Operating Temperature	T <sub>j</sub>	+150	°C
Storage Temperature	T <sub>stg</sub>	-40 to +125	°C
Net. Weight		415	g
Isolation Voltage	AC, 1min.	V <sub>isol</sub>	2500
Screw Torque	Mounting *1	3.5 [35]	N · m {kg · cm}
	Terminals *2	4.5 [45]	
	Terminals *3	1.7 [17]	

#### ● Electrical Characteristics (T<sub>c</sub>=25°C)

Items	Symbols	Test Conditions	Min.	Typ.	Max.	Units
Zero Gate Voltage Collector Current	I <sub>CEs</sub>	V <sub>GE</sub> =0V V <sub>CE</sub> =1200V T <sub>j</sub> =25°C			4.0	mA
		V <sub>GE</sub> =0V V <sub>CE</sub> =1200V T <sub>j</sub> =125°C			—	mA
Gate-Emitter Leakage Current	I <sub>GES</sub>	V <sub>CE</sub> =0V V <sub>GE</sub> =±20V			400	nA
Gate-Emitter Threshold Voltage	V <sub>GE(th)</sub>	V <sub>CE</sub> =20V I <sub>C</sub> =300mA	3.0		6.0	V
Collector-Emitter Saturation Voltage	V <sub>CE(sat)</sub>	V <sub>GE</sub> =15V I <sub>C</sub> =300A			2.5	V
Input Capacitance	C <sub>ies</sub>	V <sub>GE</sub> =0V		54000		pF
Output Capacitance	C <sub>oes</sub>	V <sub>CE</sub> =10V		—		
Reverse Transfer Capacitance	C <sub>res</sub>	f=1MHz		—		
Turn-on Time	t <sub>on</sub>	V <sub>CC</sub> =600V I <sub>C</sub> =300A	Resistive load			0.8
	t <sub>r</sub>					0.6
Turn-off Time	t <sub>off</sub>	V <sub>GE</sub> =±15V R <sub>G</sub> =2.7Ω	Inductive load			1.5
	t <sub>f</sub>					1.0
Diode Forward On-Voltage	V <sub>F</sub>	I <sub>F</sub> =300A, V <sub>GE</sub> =0V			2.5	V
Reverse Recovery Time	t <sub>rr</sub>	I <sub>F</sub> =300A, -di/dt=900A/μs V <sub>GE</sub> =-10V			350	ns

#### ● Thermal Characteristics

Items	Symbols	Test Conditions	Min.	Typ.	Max.	Units
Thermal Resistance	R <sub>th(j-c)</sub>	IGBT			0.069	°C/W
	R <sub>th(j-e)</sub>	Diode			0.111	
	R <sub>th(c-f)</sub>	With Thermal compound		0.0125		

### ■ Outline Drawings

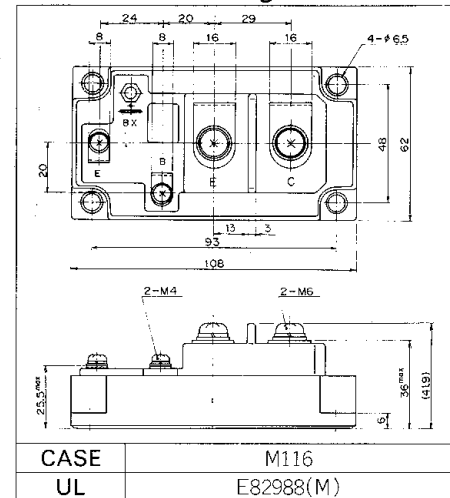

### ■ Equivalent Circuit Schematic

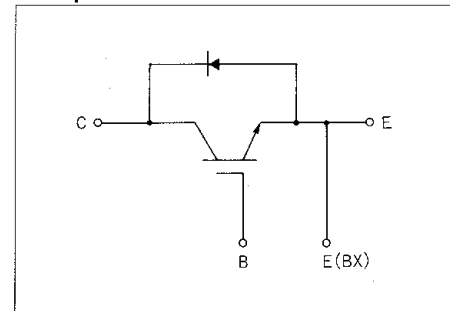

- \*1 Recommendable Value 2.5 to 3.5 N·m  
25 to 35 kg·cm (M5)
- \*2 Recommendable Value 3.5 to 4.5 N·m  
35 to 45 kg·cm (M6)
- \*3 Recommendable Value 1.3 to 1.7 N·m  
13 to 17 kg·cm (M4)

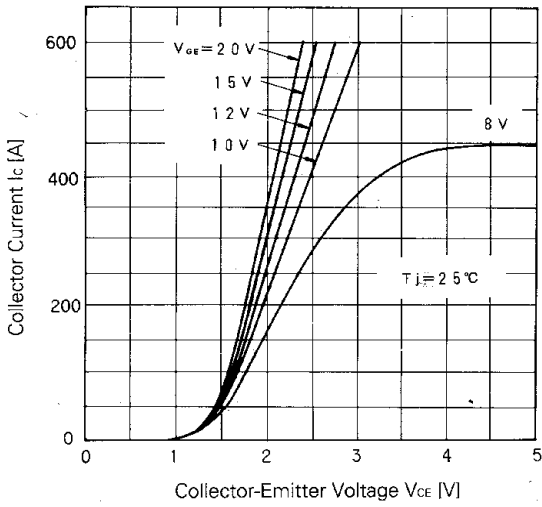

Collector Current vs. Collector-Emitter Voltage

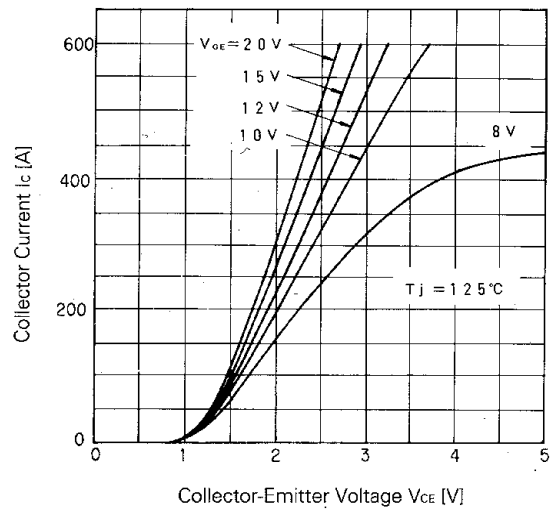

Collector Current vs. Collector-Emitter Voltage

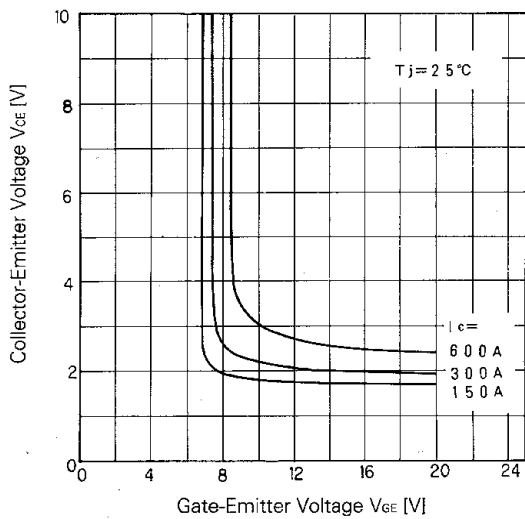

Collector-Emitter Voltage vs. Gate-Emitter Voltage

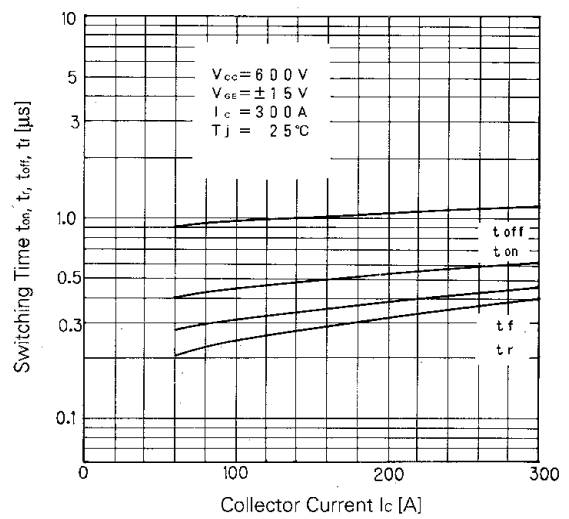

Switching Time

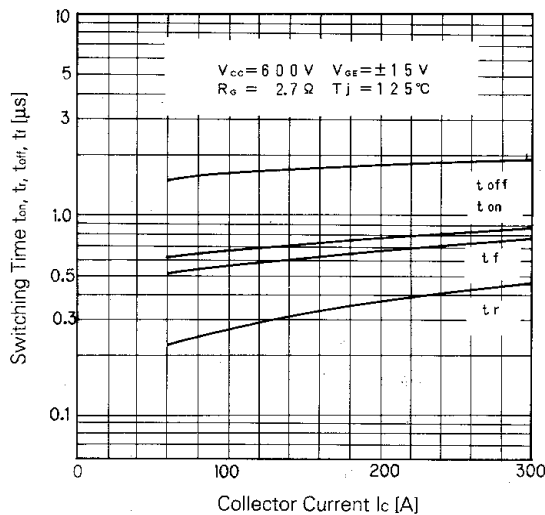

Switching Time

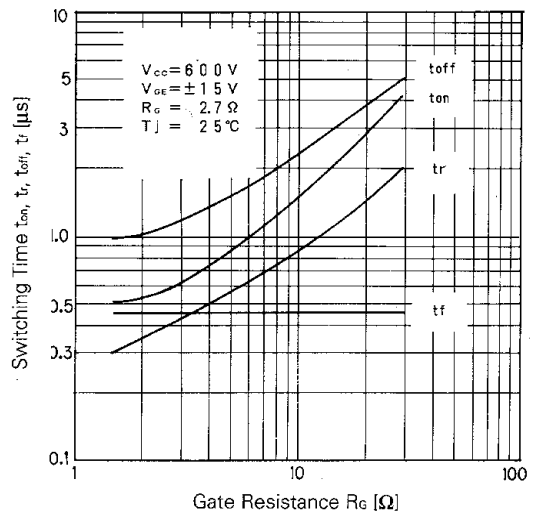

Switching Time-Gate Resistance

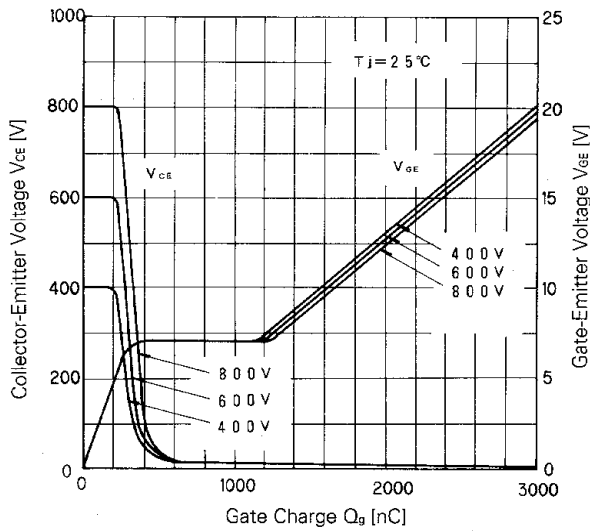

**Dynamic Input Characteristic**

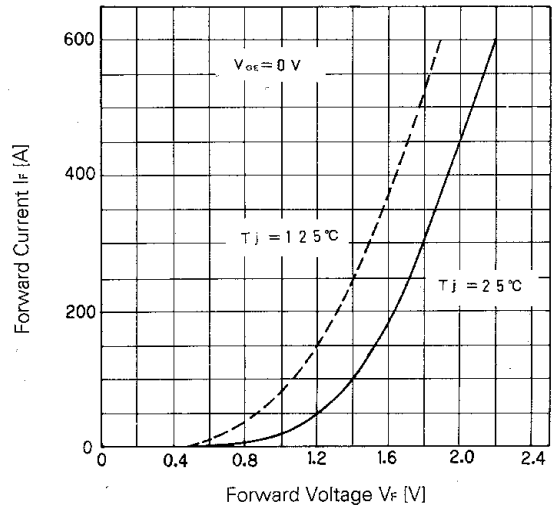

**Forward Voltage of Free Wheel Diode**

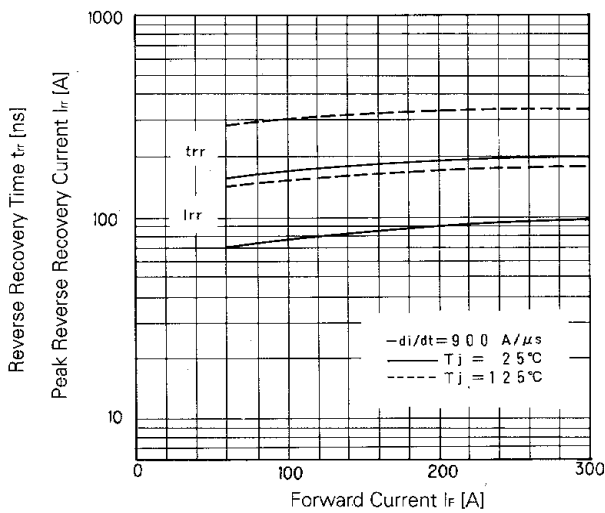

**$T_{rr}$ ,  $I_{rr}$  -  $I_f$**

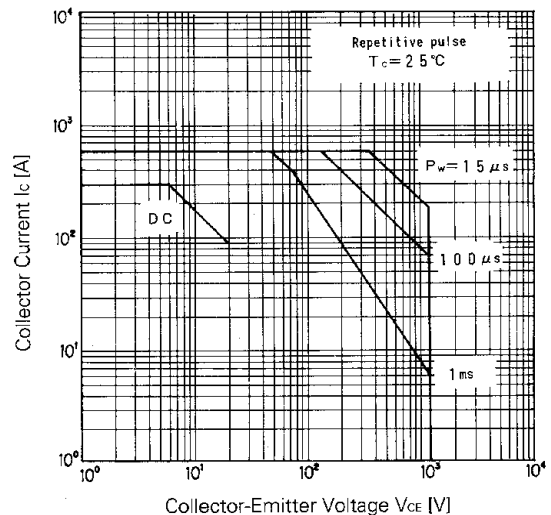

**Safe Operating Area**

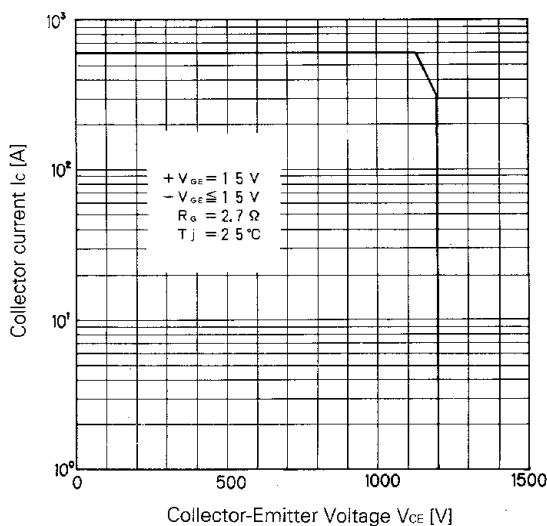

**Reverse Biased Safe Operating Area**

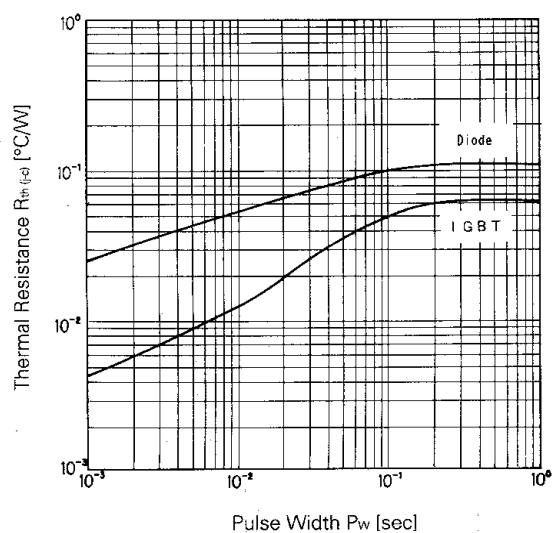

**Transient Thermal Resistance**

For more information, contact:

**Collmer Semiconductor, Inc.**

P.O. Box 702708

Dallas, TX 75370

972-233-1589

972-233-0481 Fax

<http://www.collmer.com>