

IGBT MODULE (L series)

■ Features

- High Speed Switching
- Low Saturation Voltage
- Voltage Drive
- Isolated Package

■ Applications

- Ideal for Chopper Application
- AC and DC Servo Drive Supply
- Uninterruptible Power Supply
- Industrial Machines, such as Welding Machines

■ Maximum Ratings and Characteristics

● Absolute Maximum Ratings

Items	Symbols	Ratings	Units
Collector-Emitter Voltage	V _{CES}	600	V
Gate-Emitter Voltage	V _{GES}	±20	V
Collector Current	Continuous	I _C	75
	1ms	I _{C pulse}	150
Max. Power Dissipation	P _C	300	W
Operating Temperature	T _j	+150	°C
Storage Temperature	T _{stg}	-40 to +125	°C
Isolation Voltage	AC. 1min.	V _{is}	2500
Screw Torque	Mounting *1	1.7	N•m
	Terminals *1	1.7	

● Electrical Characteristics (T_j=25°C unless otherwise specified)

Items	Symbols	Test Conditions	Min.	Typ.	Max.	Units
Zero Gate Voltage Collector Current	I _{CES}	V _{GE} =0V V _{CE} =600V T _c =25°C			1.0	mA
Gate-Emitter Leakage Current	I _{GES}	V _{CE} =0V V _{GE} ±20V			100	nA
Gate-Emitter Threshold Voltage	V _{GE(th)}	V _{CE} =20V I _C =75mA	3.0		6.0	V
Collector-Emitter Saturation Voltage	V _{CE(sat)}	V _{GE} =15V I _C =75A		2.7	3.5	V
Input Capacitance	C _{ies}	V _{GE} =0V		7100		pF
Output Capacitance	C _{oes}	V _{CE} =10V		-		
Reverse Transfer Capacitance	C _{res}	f=1MHz		-		
Turn-on Time	t _{on}	V _{CC} =300V		0.4	0.8	μs
	t _r	I _C =75A		0.3	0.6	
Turn-off Time	t _{off}	V _{GE} ±15V		0.6	1.0	
	t _f	R _C =33Ω		0.2	0.35	

t_{on}, t_r: Resistive Load t_{off}, t_f: Inductive Load

● Thermal Characteristics

Items	Symbols	Test Conditions	Min.	Typ.	Max.	Units
Thermal Resistance	R _{th(j-c)}	IGBT			0.417	°C/W
	R _{th(c-f)}	With Thermal compound		0.06		

■ Outline Drawings

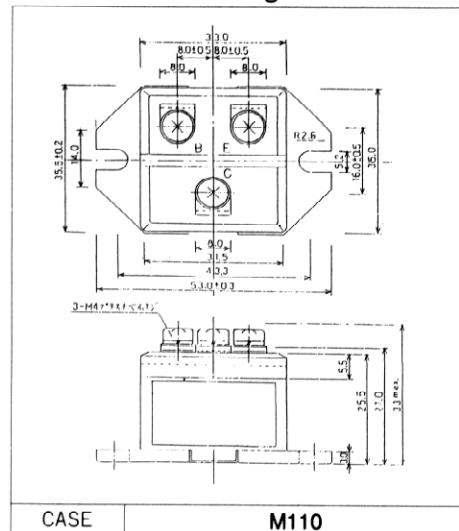

■ Equivalent Circuit Schematic

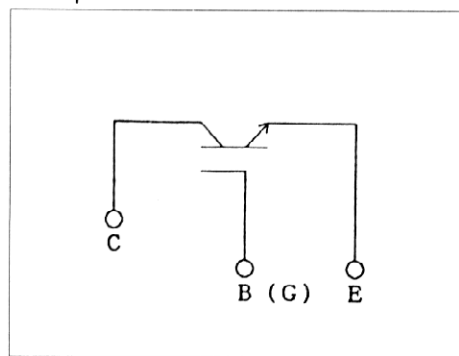

*1 Recommendable Value 1.3 ~ 1.7 N•m (M4)

■ Characteristics

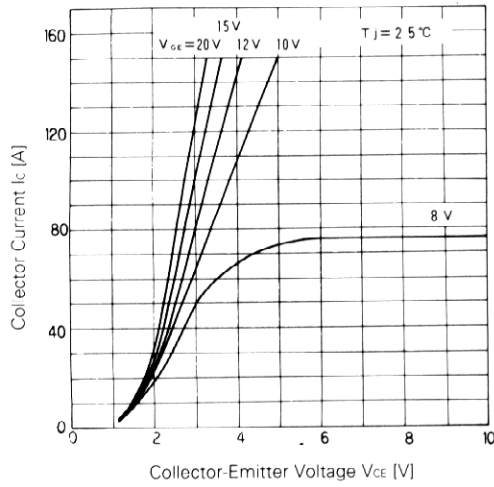

Collector Current vs. Collector-Emitter Voltage

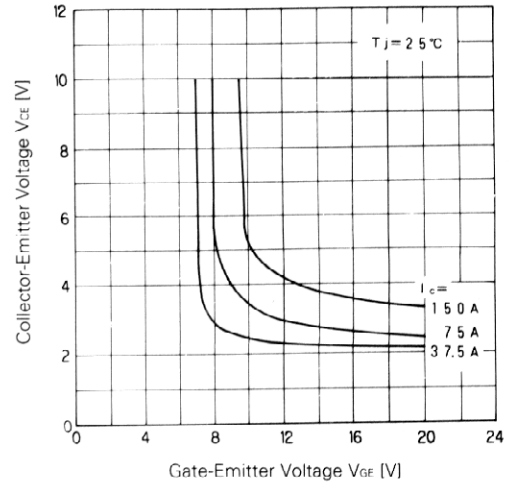

Collector-Emitter Voltage vs. Gate-Emitter Voltage

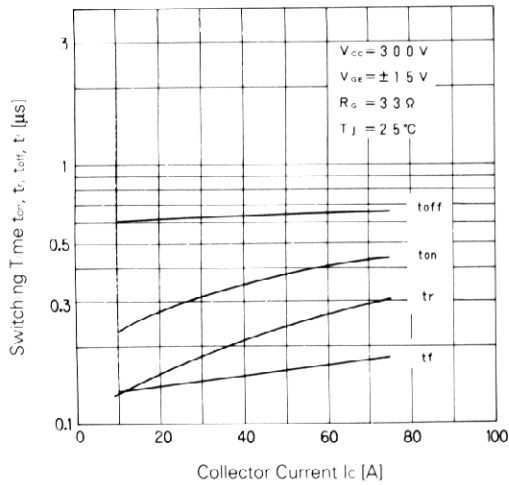

Switching Time

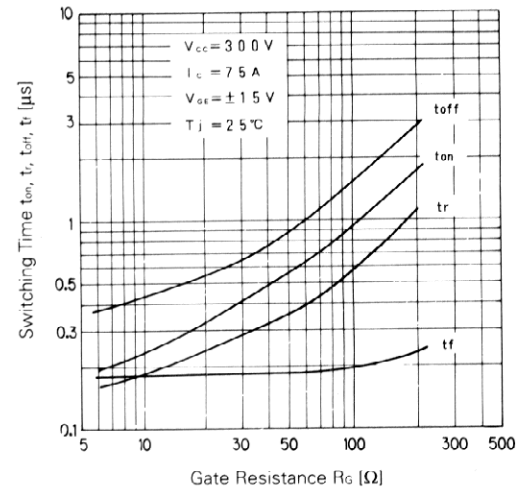

Switching Time-Gate Resistance

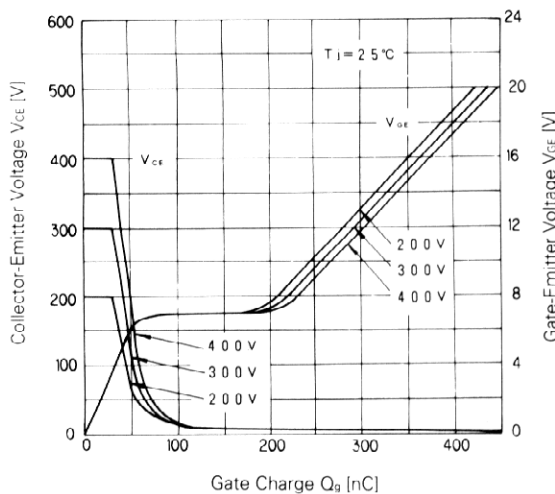

Dynamic Input Characteristic

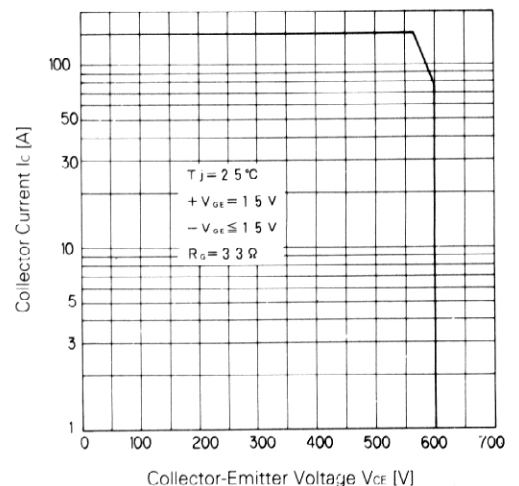

Reverse Biased Safe Operating Area

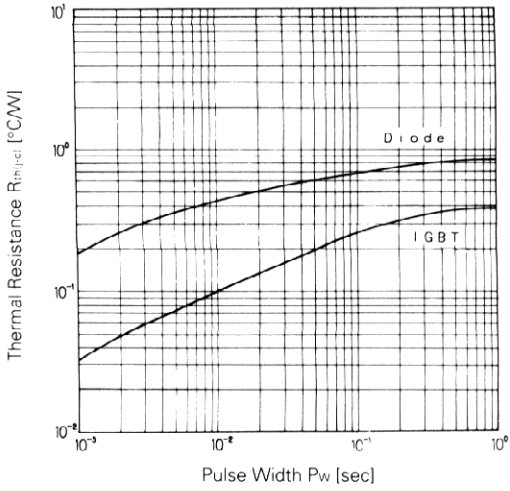

Transient Thermal Resistance

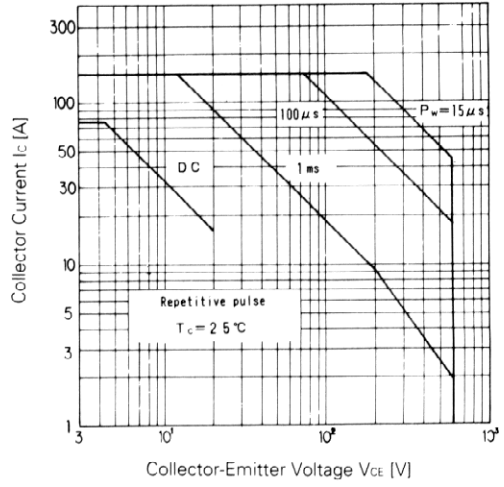

Safe Operating Area

This datasheet has been download from:

www.datasheetcatalog.com

Datasheets for electronics components.