

Intelligent Power Module (R-Series)

Maximum Ratings and Characteristics

Absolute Maximum Ratings ($T_c=25^\circ\text{C}$)

| Items | Symbols | Ratings | | Units |
|--|----------------------|----------|----------|------------------|
| | | Min. | Max. | |
| DC Bus Voltage | V_{DC} | 0 | 450 | V |
| DC Bus Voltage (surge) | $V_{DC(Surge)}$ | 0 | 500 | |
| DC Bus Voltage (short operating) | V_{SC} | 200 | 400 | |
| Collector-Emitter Voltage | V_{CES} | 0 | 600 | |
| Inverter Collector Current | Continuous | I_C | 150 | A |
| | 1ms | I_{CP} | 300 | |
| | Duty=58.8% | $-I_C$ | 150 | |
| Collector Power Dissipation (One Transistor) | P_C | | 595 | W |
| Voltage of Power Supply for Driver | V_{CC}^{*1} | 0 | 20 | V |
| Input Signal Voltage | V_{IN}^{*2} | 0 | V_Z | V |
| Input Signal Current | I_{IN} | | 1 | mA |
| Alarm Signal Voltage | V_{ALM}^{*3} | 0 | V_{CC} | V |
| Alarm Signal Current | I_{ALM}^{*4} | | 15 | mA |
| Junction Temperature | T_J | | 150 | $^\circ\text{C}$ |
| Operating Temperature | T_{OP} | -20 | 100 | |
| Storage Temperature | T_{stg} | -40 | 125 | |
| Isolation Voltage | A.C. 1min. V_{iso} | | 2500 | |
| Screw Torque | Mounting *1 | | 3.5 | Nm |
| | Terminals *1 | | 3.5 | |

Note: *1 : Recommendable Value; 2.5 – 3.0 Nm (M5)

Outline Drawing

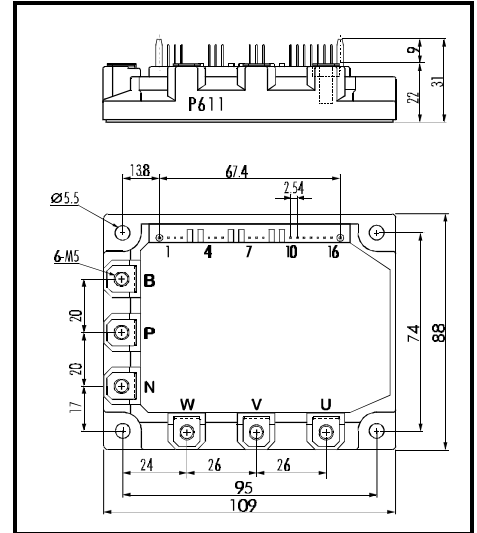

Fig. 1

Electrical Characteristics of Power Circuit (at $T_J=25^\circ\text{C}$, $V_{CC}=15\text{V}$)

| Items | Symbols | Conditions | Min. | Typ. | Max. | Units |
|-------|---------------------------------------|---------------|--|------|------|-------|
| INV | Collector Current At Off Signal Input | I_{CES} | $V_{CE}=600\text{V}$, Input Terminal Open | | 1.0 | mA |
| | Collector-Emitter Saturation Voltage | $V_{CE(Sat)}$ | $I_C=150\text{A}$ | | 2.8 | V |
| | Forward Voltage of FWD | V_F | $-I_C=150\text{A}$ | | 3.0 | V |

Electrical Characteristics of Control Circuit (at $T_J=25^\circ\text{C}$, $V_{CC}=15\text{V}$)

| Items | Symbols | Conditions | Min. | Typ. | Max. | Units |
|---|--------------|---|------|------|------|------------------|
| Current of P-Line Side Driver (One Unit) | I_{CCP} | $f_{SW}=0\sim 15\text{kHz}$, $T_C=-20\sim 100^\circ\text{C}$ | 3 | | 18 | mA |
| Current of N-Line Side Driver (Three Units) | I_{CCN} | $f_{SW}=0\sim 15\text{kHz}$, $T_C=-20\sim 100^\circ\text{C}$ | 10 | | 65 | |
| Input Signal Threshold Voltage | $V_{IN(th)}$ | On | 1.00 | 1.35 | 1.70 | V |
| | | Off | 1.25 | 1.60 | 1.95 | |
| Input Zener Voltage | V_Z | $R_{IN}=20\text{k}\Omega$ | | 8.0 | | |
| Over Heating Protection Temperature Level | T_{COH} | $V_{DC}=0\text{V}$, $I_C=0\text{A}$, Case Temp. | 110 | | 125 | $^\circ\text{C}$ |
| Hysteresis | T_{CH} | | | 20 | | |
| IGBT Chips Over Heating Protec. Temp. Level | T_{IOH} | Surface of IGBT Chip | 150 | | | |
| Hysteresis | T_{IH} | | | 20 | | |
| Inverter Collector Current Protection Level | I_{OC} | $T_J=125^\circ\text{C}$ | 225 | | | A |
| Over Current Detecting Time | t_{DOC} | $T_J=25^\circ\text{C}$ | | 10 | | μs |
| Alarm Signal Hold Time | t_{ALM} | | 1.5 | 2 | | ms |
| Limiting Resistor for Alarm | R_{ALM} | | 1425 | 1500 | 1575 | Ω |
| Under Voltage Protection Level | V_{UV} | | 11.0 | | 12.5 | V |
| Hysteresis | V_H | | 0.2 | | | |

Dynamic Characteristics (at $T_C=T_J=125^\circ\text{C}$, $V_{CC}=15\text{V}$)

| Items | Symbols | Conditions | Min. | Typ. | Max. | Units |
|----------------|-----------|--|------|------|------|---------------|
| Switching Time | t_{ON} | $I_C=150\text{A}$, $V_{DC}=300\text{V}$ | 0.3 | | | μs |
| | t_{OFF} | | | | 3.6 | |
| | t_{RR} | $I_F=150\text{A}$, $V_{DC}=300\text{V}$ | | | 0.4 | |

Thermal Characteristics

| Items | Symbols | Conditions | Min. | Typ. | Max. | Units |
|--------------------|---------------|-----------------------|------|------|------|--------------------|
| Thermal Resistance | $R_{th(i-c)}$ | Inverter IGBT | | | 0.21 | $^\circ\text{C/W}$ |
| | $R_{th(i-c)}$ | Diode | | | 0.47 | |
| | $R_{th(c-f)}$ | With Thermal Compound | | 0.05 | | |

■ Equivalent Circuit

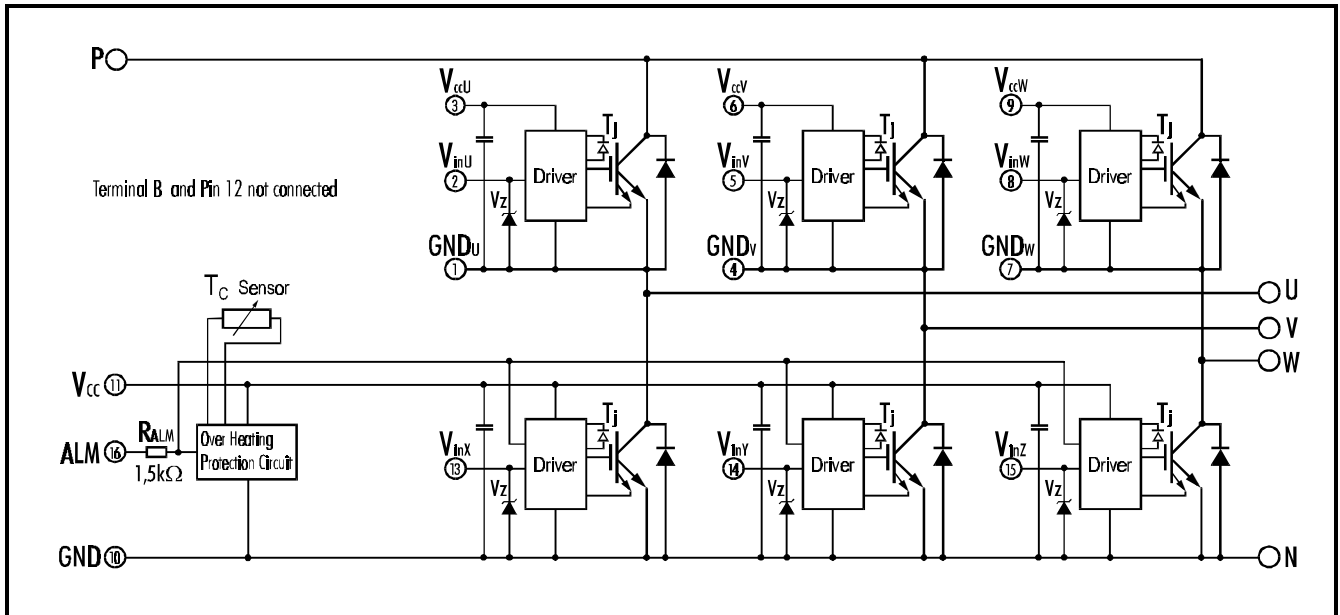

Drivers include following functions

- Short circuit protection circuit
- Amplifier for driver
- Undervoltage protection circuit
- Overcurrent protection circuit
- IGBT Chip overheating protection

Control Circuit

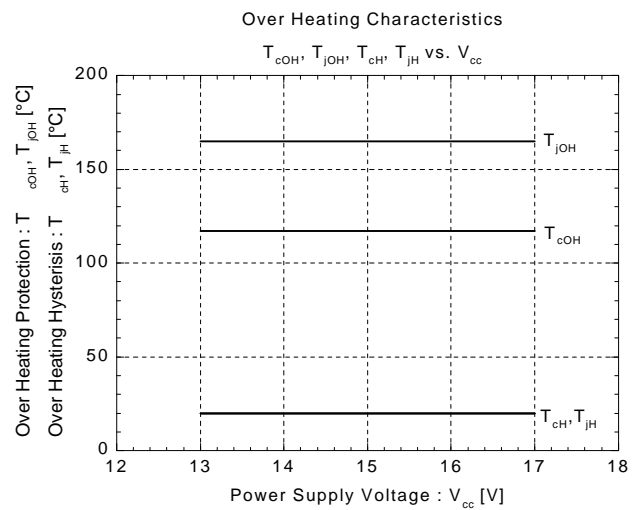
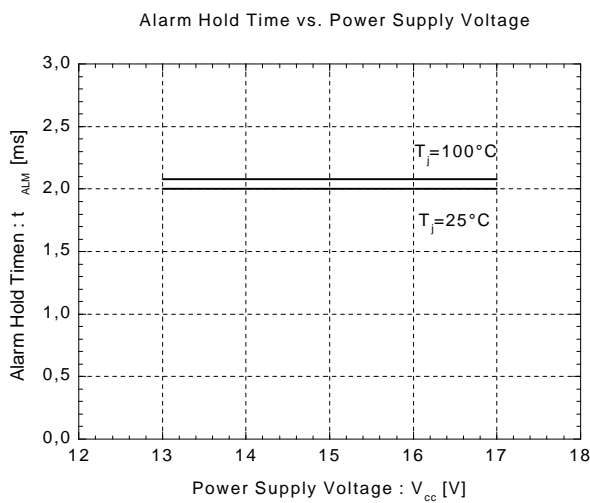
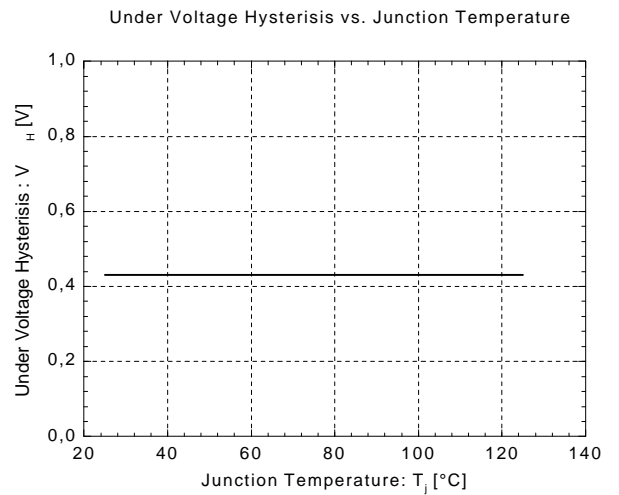
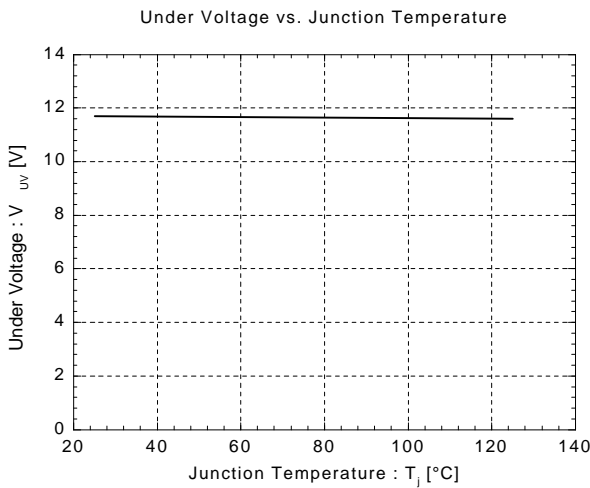
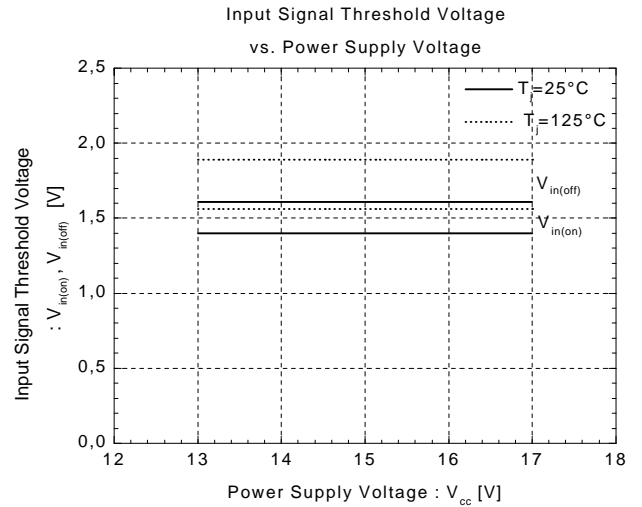
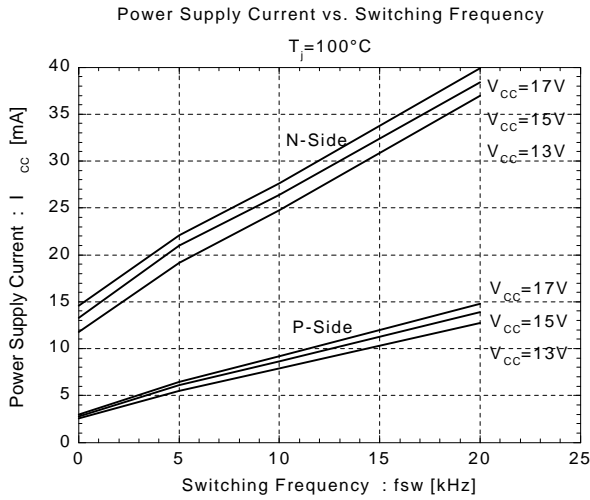

■ **Inverter**

Collector Current vs. Collector-Emitter Voltage

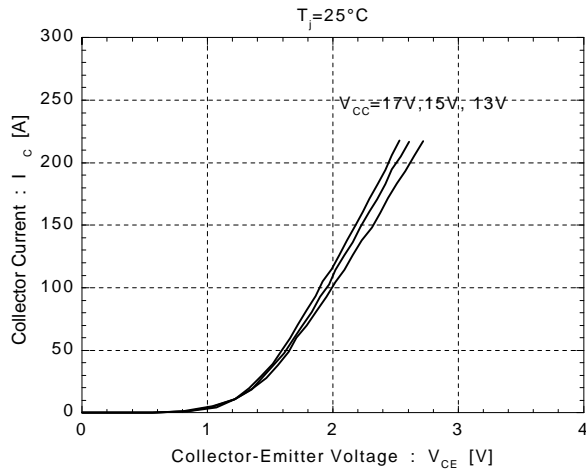

Collector Current vs. Collector-Emitter Voltage

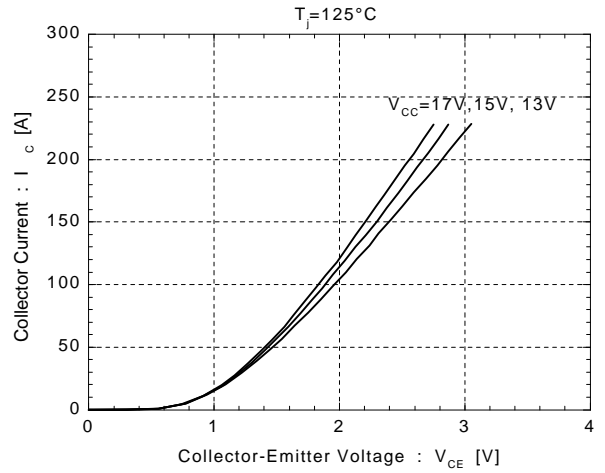

Switching Time vs. Collector Current

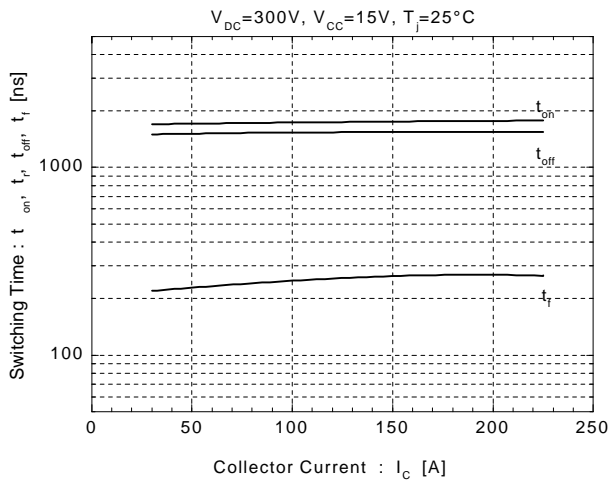

Switching Time vs. Collector Current

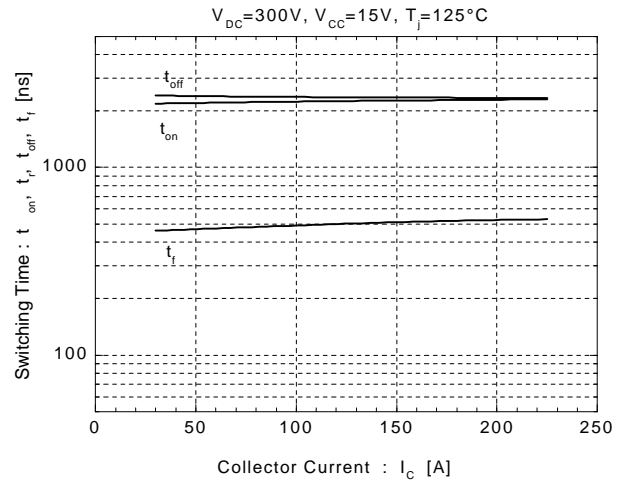

Forward Voltage vs. Forward Current

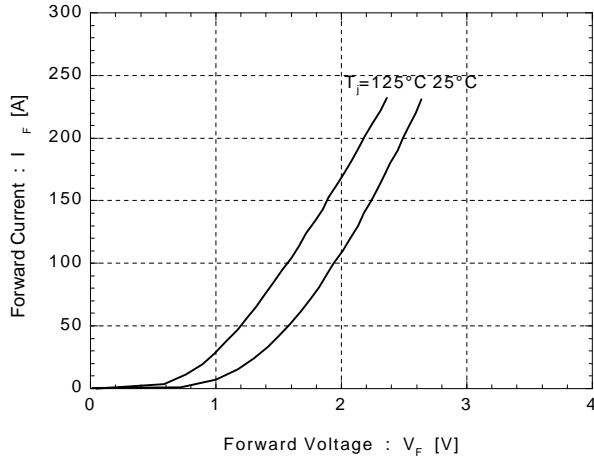

Reverse Recovery Characteristics

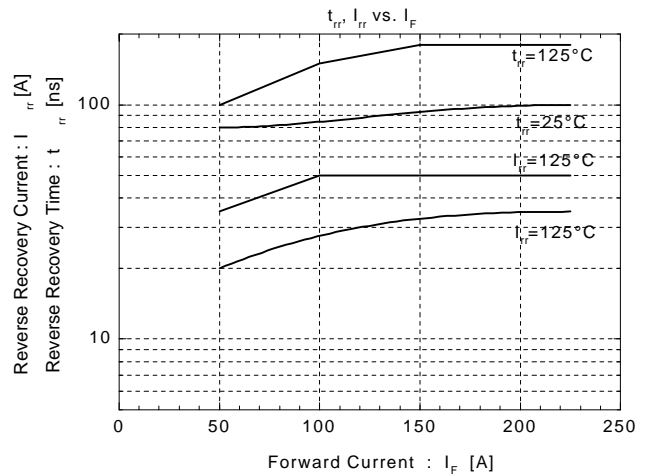

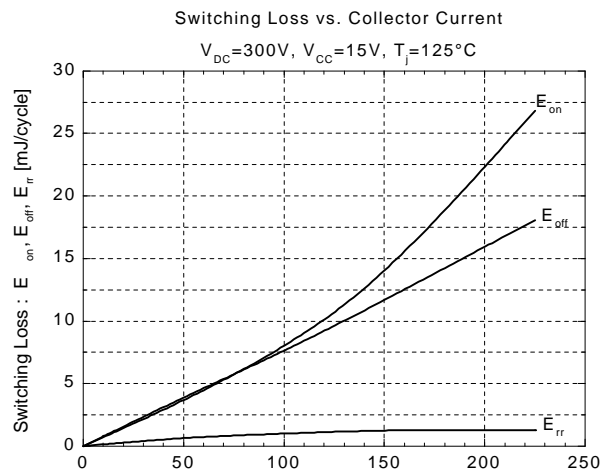
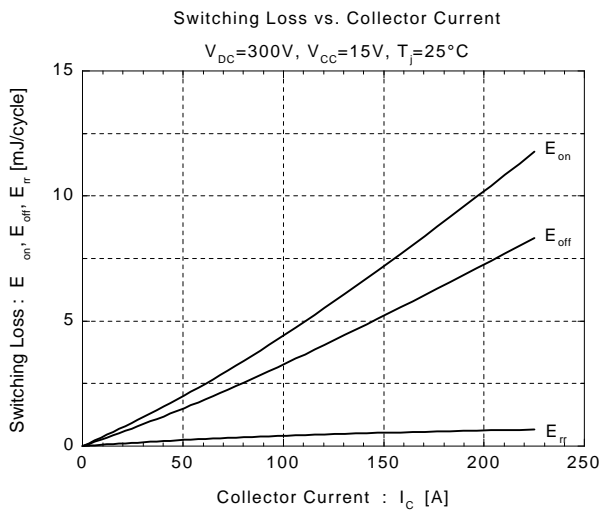
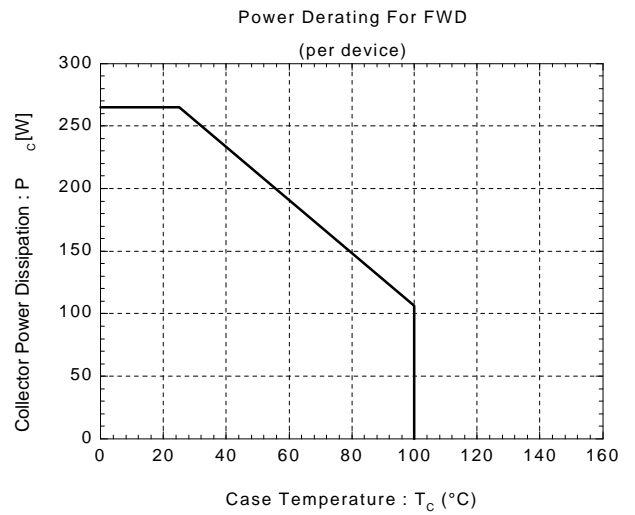
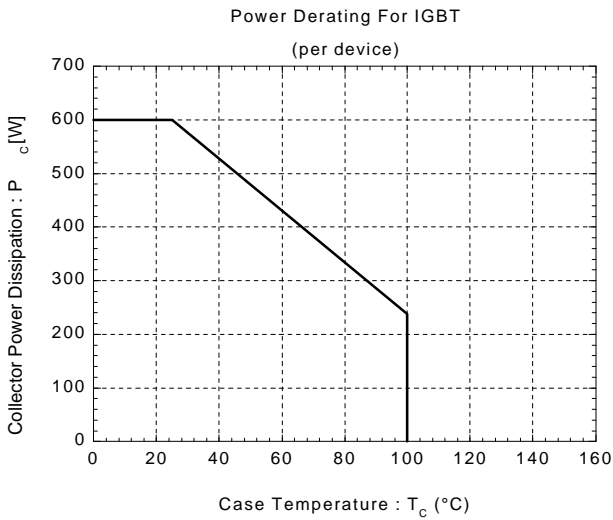
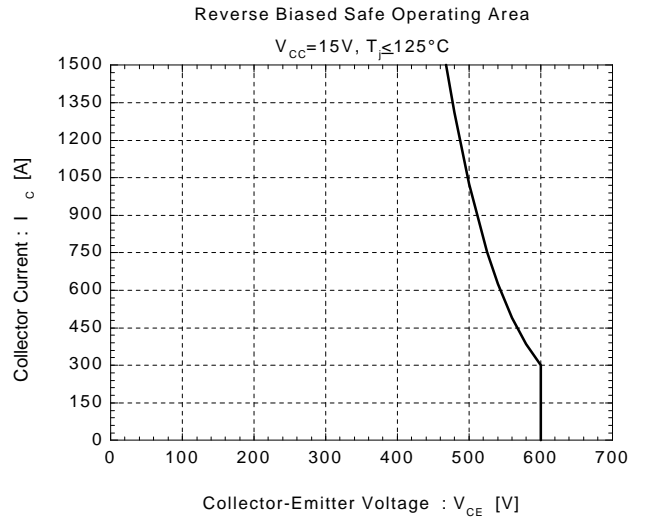
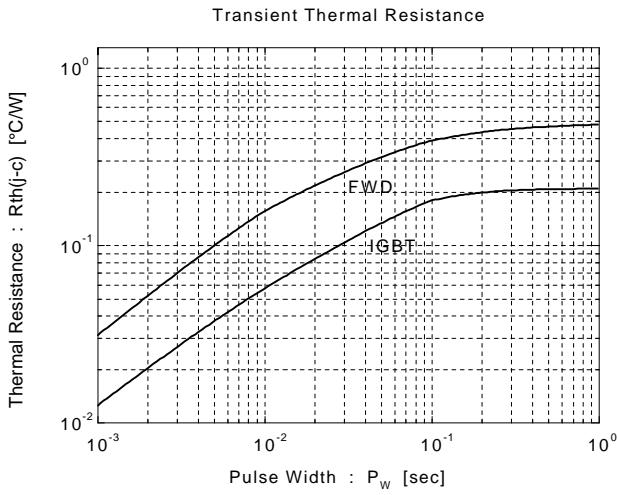

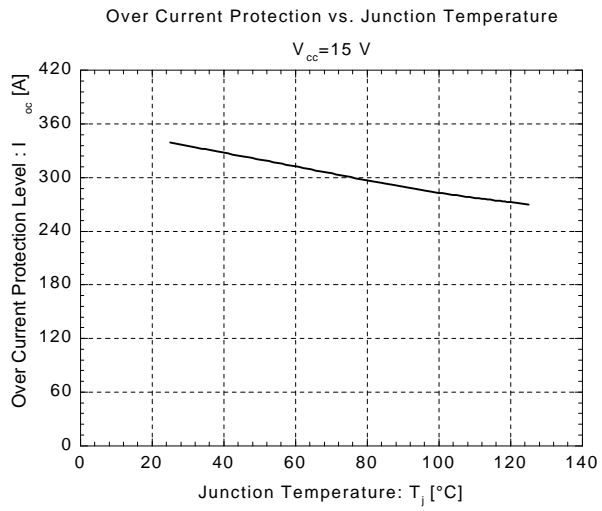

■ Outline Drawing

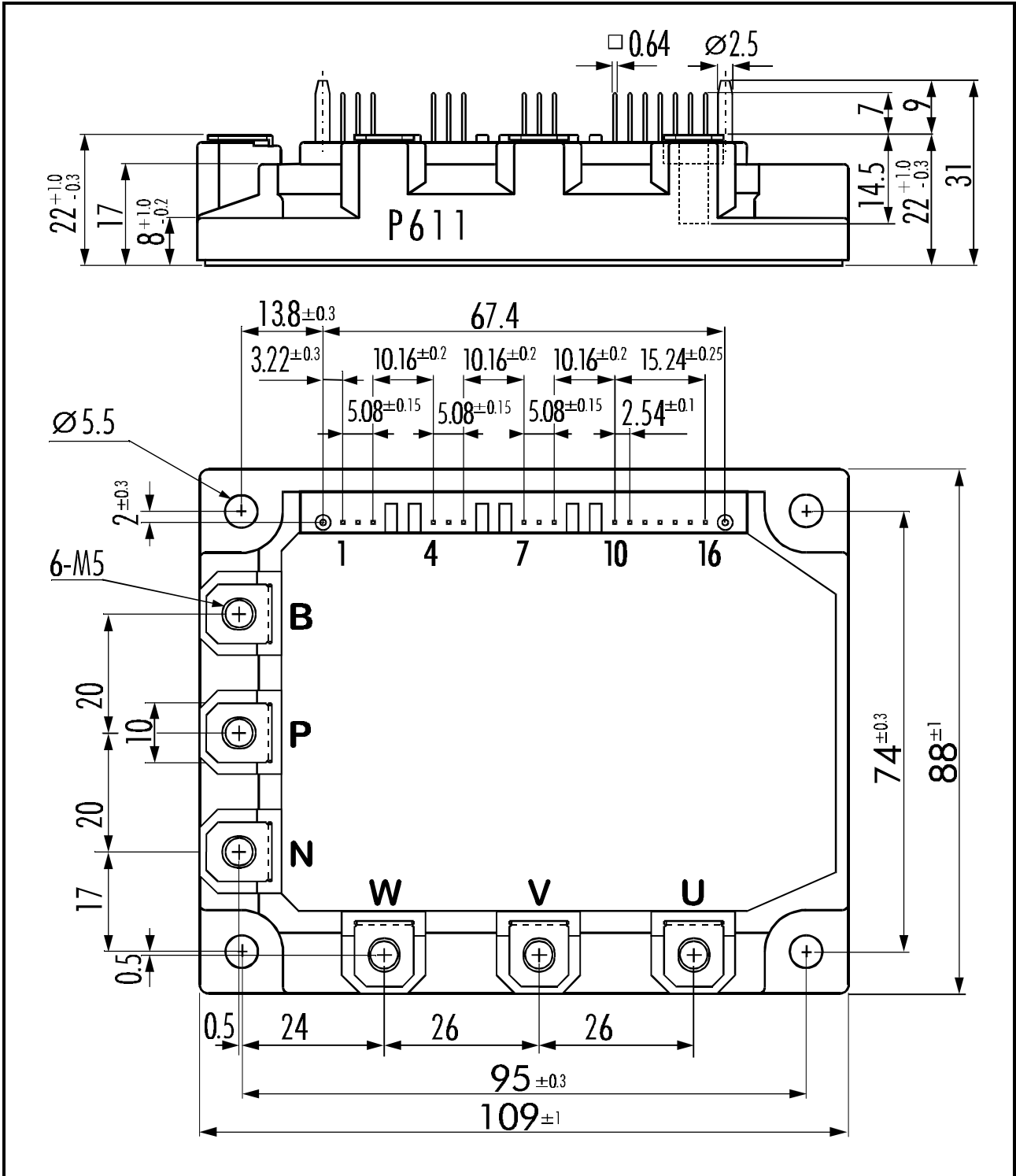

Weight: 440g