

IGBT-IPM R series

600V / 30A / 6 in one-package

■ Features

- Low power loss and soft switching
- High performance and high reliability IGBT with overheating protection
- Higher reliability because of a big decrease in number of parts in built-in control circuit

■ Applications

- Inverter for motor drive
- AC and DC servo drive amplifier
- UPS (Uninterruptible power supply)

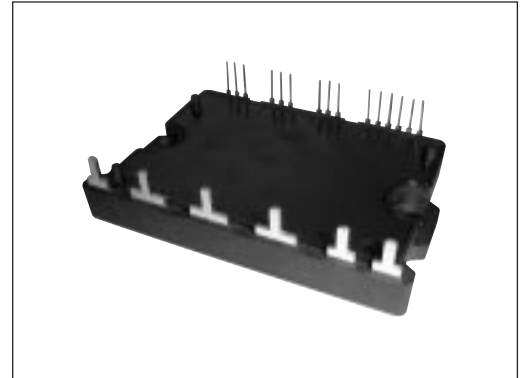

■ Maximum ratings and characteristics

● Absolute maximum ratings (T_c=25°C unless otherwise specified)

Item	Symbol	Rating	Unit
DC bus voltage	V _{DC}	450	V
DC bus voltage (Surge)	V _{DC (surge)}	500	V
DC bus voltage (Short operating)	V _{SC}	400	V
Collector-Emitter voltage	V _{CES}	600	V
Collector current	DC	I _c	30
	1ms	I _{CP}	60
	Duty=56.6%	-I _c	30
Collector power dissipation	One transistor	P _c	85
Junction temperature	T _j	150	°C
Input voltage of power supply for pre-driver	V _{CC}	-0.3 to 20	V
Input signal voltage	V _{in}	V _Z	V
Input signal current	I _{in}	1	mA
Alarm signal voltage	V _{ALM}	V _{CC}	V
Alarm signal current	I _{ALM}	15	mA
Storage temperature	T _{stg}	-40 to 125	°C
Operating case temperature	T _{cop}	-20 to 100	°C
Isolating voltage (Terminal to base, 50/60Hz sine wave 1min.)	V _{iso}	AC 2500	V
Screw torque	Mounting (M4)	2.0	N • m

● Electrical characteristics of power circuit (T_c=T_j=25°C, V_{CC}=15V)

Item	Symbol	Condition	Min.	Typ.	Max.	Unit
Collector current at off signal input	I _{CES}	V _{CE} =600V, V _{in} open	-	-	1.0	mA
Collector-Emitter saturation voltage	V _{CE (sat)}	I _c =30A	-	-	2.7	V
Forward voltage of FWD	V _F	-I _c =30A	-	-	3.5	V

● Electrical characteristics of control circuit (T_c=T_j=25°C, V_{cc}=15V)

Item	Symbol	Condition	Min.	Typ.	Max.	Unit
Power supply current of P-line pre-driver (one unit)	I _{CCP}	V _{in} =H	–	2.0	5.0	mA
Power supply current of N-line pre-driver	I _{CCN}	V _{in} =H	–	4.0	10.0	mA
Input signal threshold voltage	V _{in (th)}	Turn-on	1.00	1.35	1.70	V
		Turn-off	1.25	1.60	1.95	V
Input zener voltage	V _Z	R _{in} =20kΩ	–	8.0	–	V
IGBT chips overheat protection temperature level	T _{joH}	Surface of IGBT	150	–	–	°C
Hysteresis	T _{jH}		–	20	–	°C
Collector current protection level	I _{oc}	N-side, (N1-N2 open)	44	54	64	A
	V _{oc}	Between N1 and N2	190	200	210	mV
OC detecting resistance value	R _{oc}		–	3.7	–	mΩ
Protection delay time	t _{DOC}	T _j =25°C Fig. 1, Fig. 2	–	5.0	7.0	μs
Undervoltage protection level	V _{UV}		11.0	–	12.5	V
Hysteresis	V _H		0.2	–	0.8	V
Alarm signal hold time	t _{ALM}		1.0	2.0	–	ms

● Switching characteristics (T_c=T_j=25°C, V_{cc}=15V)

Item	Symbol	Condition	Min.	Typ.	Max.	Unit
Switching time (IGBT) See Fig. 3	t _{on}	I _c =30A, V _{DC} =300V	0.5	–	–	μs
	t _{off}	Inductive-Load	–	–	3.5	μs
Switching time (FWD)	t _{rr}		–	–	0.5	μs

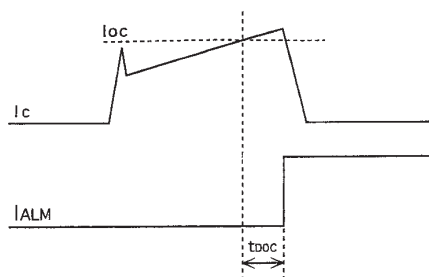

Fig.1 Definition of OC delay time

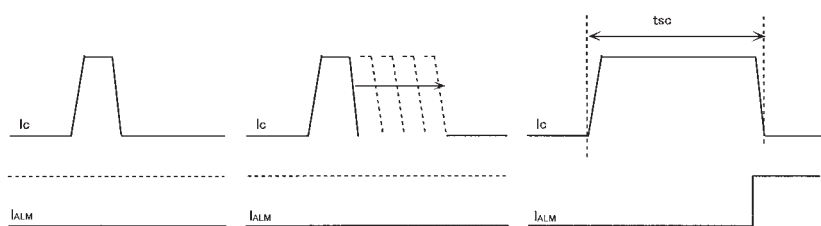

Fig.2 Definition of tsc

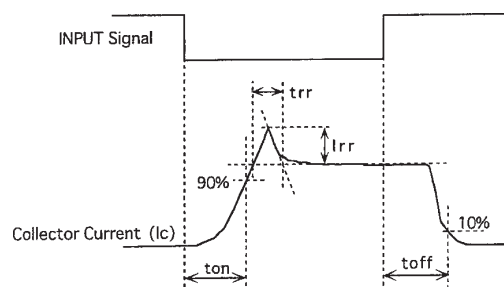

Fig.3 Definition of switching time

● Thermal characteristics (T_c=T_j=25°C, V_{cc}=15V)

Item	Symbol	Min.	Typ.	Max.	Unit	
Junction to case thermal resistance	IGBT	R _{th (j-c)}	–	–	1.47	°C/W
	FWD	R _{th (j-c)}	–	–	2.1	°C/W
Case to fin thermal resistance with compound	R _{th (c-f)}	–	0.05	–	°C/W	

● Recommendable value

Item	Symbol	Min.	Typ.	Max.	Unit
DC bus voltage	V _{DC}	200	–	400	V
Operating power supply voltage range of pre-drive	V _{CC}	13.5	15	16.5	V
Switching frequency	f _{sw}	1	–	20	kHz
Flatness of heat sink	–	–100	–	100	μm
Mounting screw torque (M4)	–	1.3	–	1.7	N • m

■ Block diagram

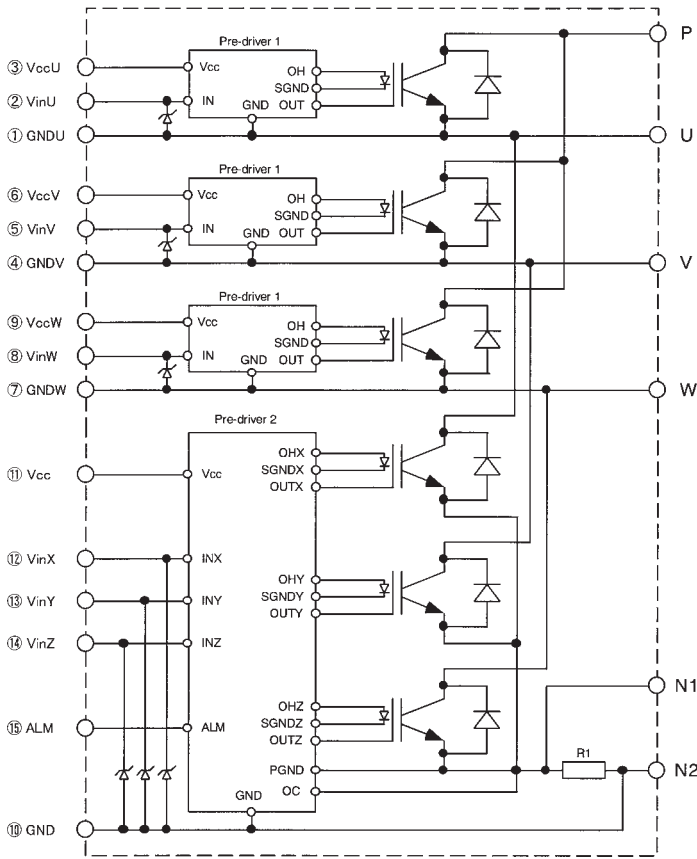

Pre-driver 1 includes following functions. (P-side)

- Amplifier for drive
- Power supply undervoltage protection
- IGBT chip overheating protection

Pre-driver 2 includes following functions. (N-side)

- Amplifier for drive
- Power supply undervoltage protection
- IGBT chip overheating protection
- Overcurrent protection
- Alarm signal output

■ Outline drawings, mm

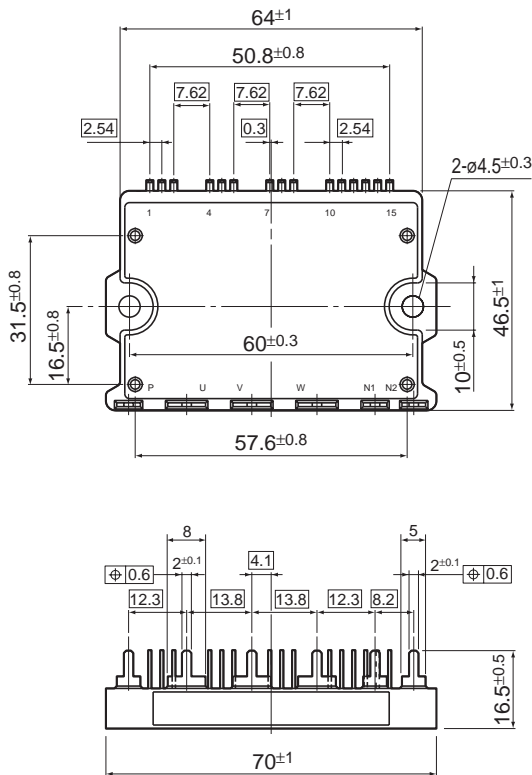

Mass: 50g

■ Characteristics (Representative)

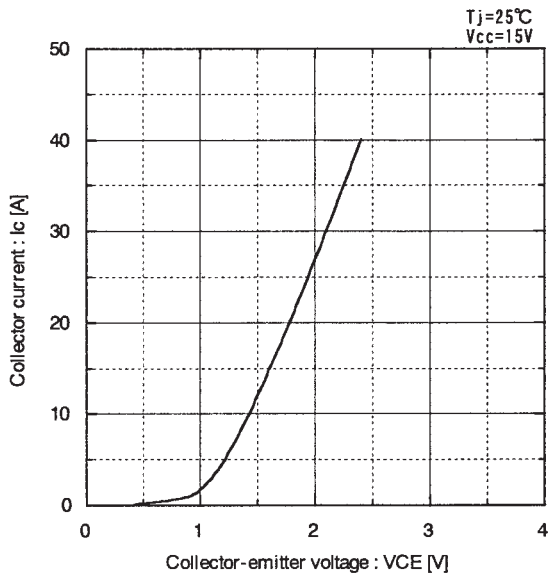

Collector current vs. Collector-emitter voltage

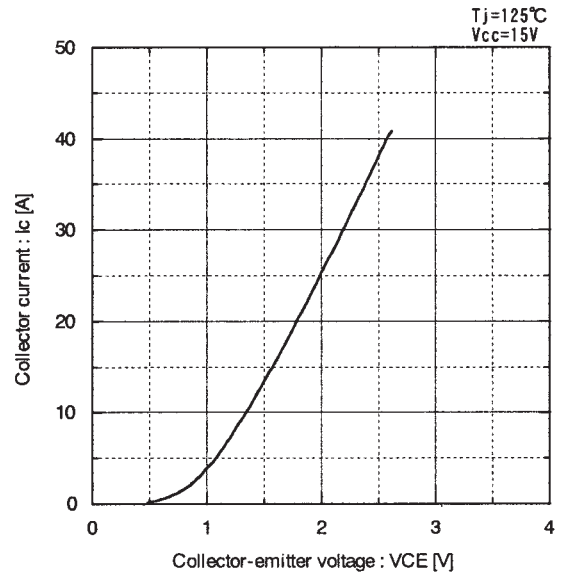

Collector current vs. Collector-emitter voltage

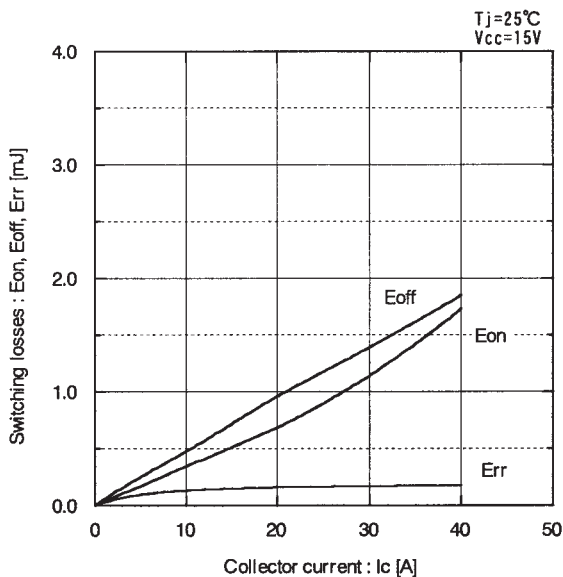

Switching losses vs. Collector current

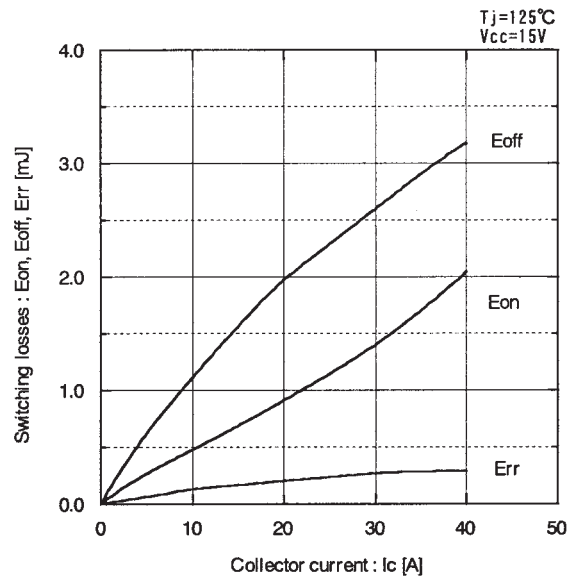

Switching losses vs. Collector current

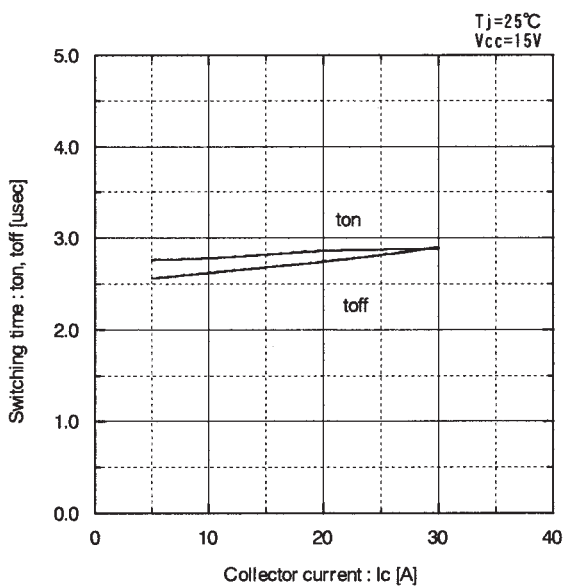

Switching time vs. Collector current

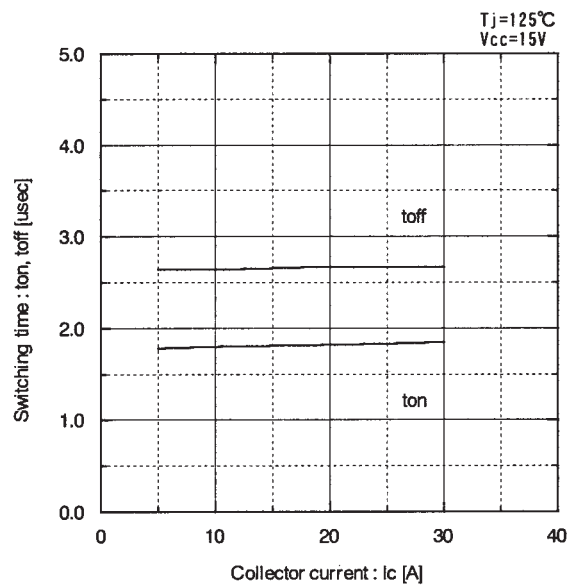

Switching time vs. Collector current

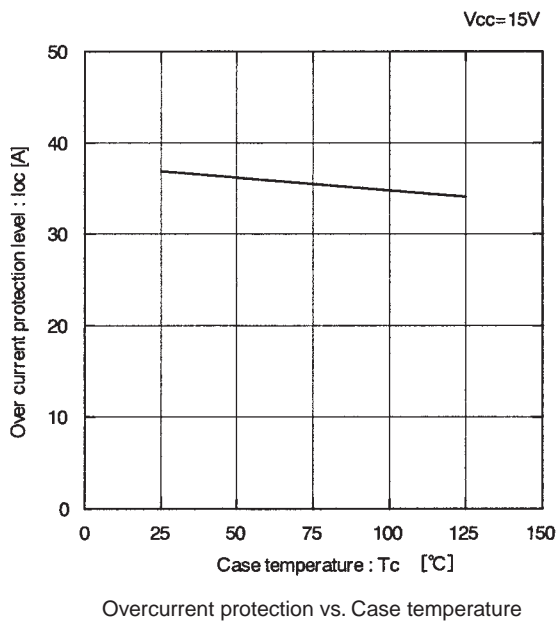
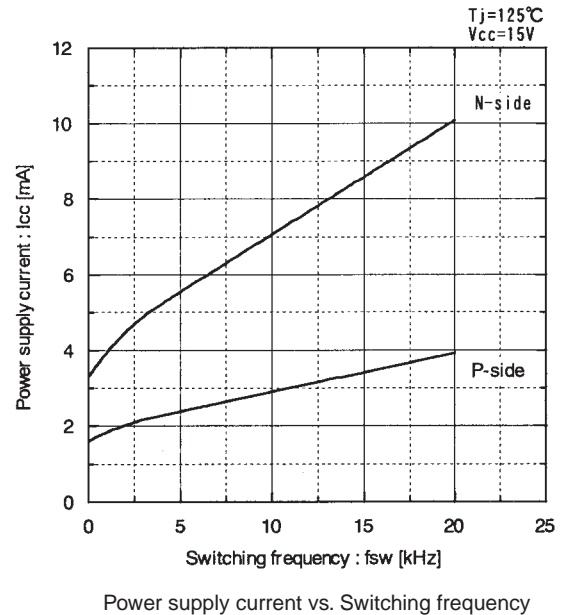
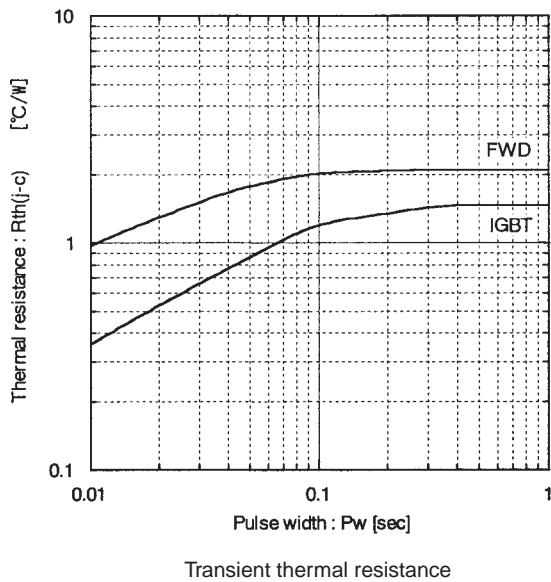
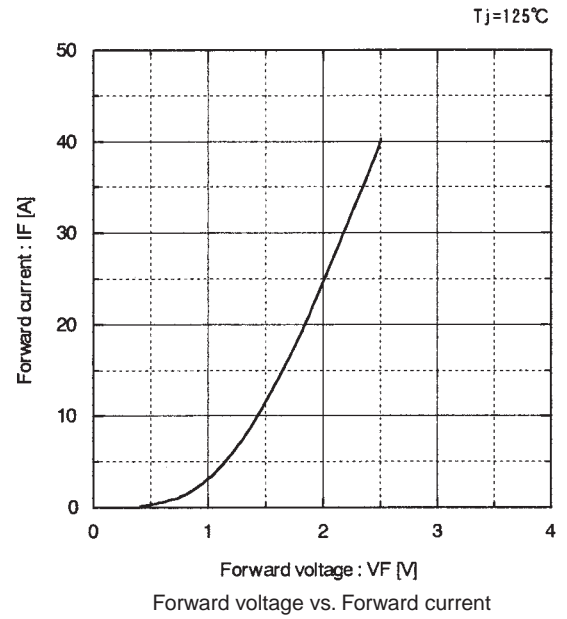
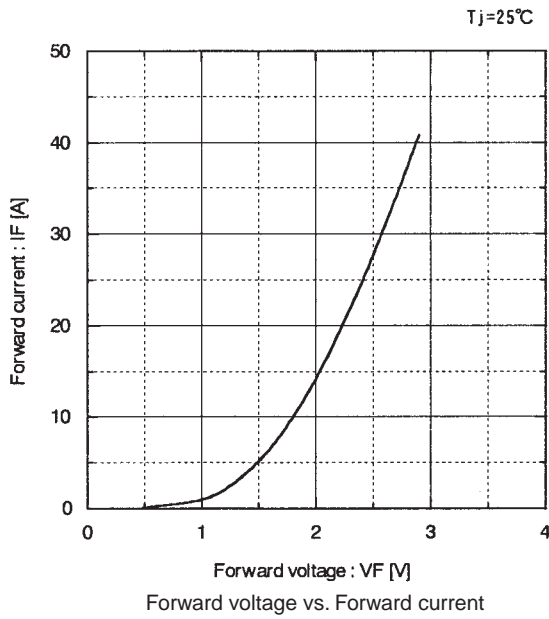

This datasheet has been download from:

www.datasheetcatalog.com

Datasheets for electronics components.