

SPECIFICATION

Device Name : IGBT module

Type Name : 7MBR30NF060

Spec. No. : **MS6M0255**

This material and the information herein is the property of Fuji Electric Co. Ltd. They shall be neither reproduced, copied, lent, or disclosed in any way whatsoever for the use of any third party nor used for the manufacturing purposes without the express written consent of Fuji Electric Co., Ltd.

Fuji Electric Co., Ltd.
Matsumoto Factory

	DATE	NAME	APPROVED	Fuji Electric Co., Ltd.	
DRAWN	Oct. - 3 - '95	S. Miyashita	<i>E. Miyashita</i>	DWG. NO.	MS6M0255
CHECKED	Oct. - 3 - '95	T. HOSEN			

Revised Records

Date	Classi- fication	Ind.	Content	Applied date	Drawn	Checked	Approved
Oct. - 3 - 45	enactment	—	—————	Issued date	—	T. MOSEN	S. Kobayashi

This material and the information herein is the property of Fuji Electric Co., Ltd. They shall be neither reproduced, copied, lent, or disclosed in any way whatsoever for the use of any third party nor used for the manufacturing purposes without the express written consent of Fuji Electric Co., Ltd.

Fuji Electric Co., Ltd.

DWG. NO.

MSGMO255

2/10

7 M B R 3 0 N F 0 6 0

1. Outline Drawing

Unit : mm

*Isolation Voltage (Terminal to Case) : AC 2500V 1 minute

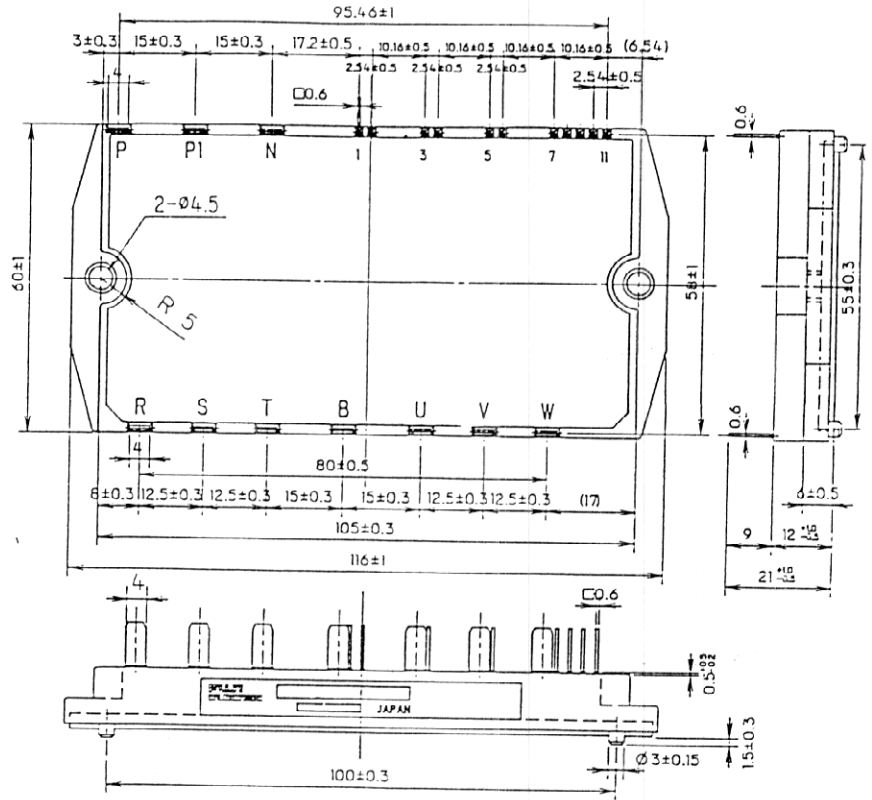

This material and the information herein is the property of Fuji Electric Co. Ltd. They shall be neither reproduced, copied, lent, or disclosed in any way whatsoever for the use of any third party without the written consent of Fuji Electric Co., Ltd.

2. Equivalent Circuit of Module

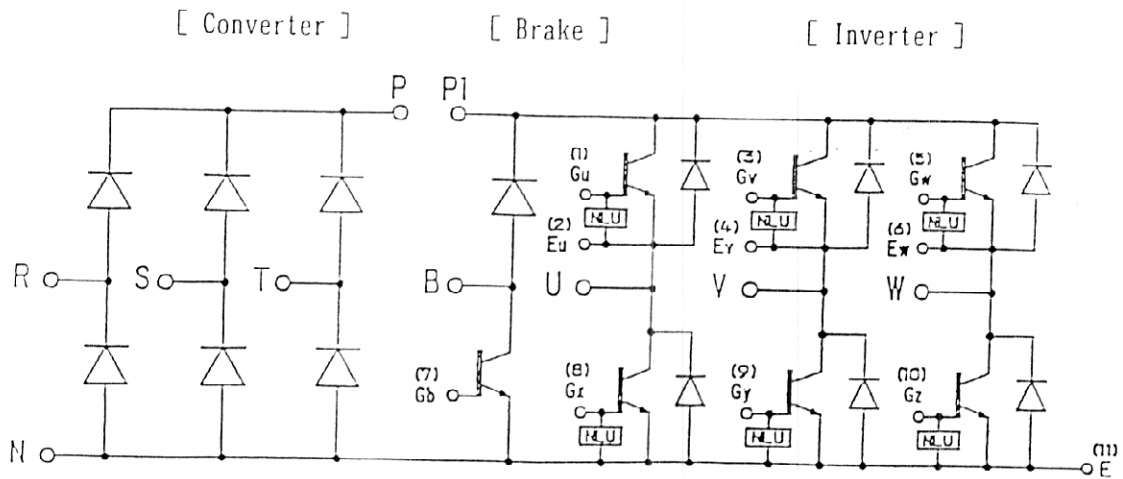

* NLU (Over current Limiting circuit)

3. Absolute Maximum Ratings (Tc=25°C unless without specified)

Items		Symbols	Conditions	Maximum Ratings	Units
Inverter	Collector-Emitter Voltage	V _{CEs}		600	V
	Gate-Emitter Voltage	V _{GEs}		±20	V
	Collector Current	I _c	Continuous	30	A
		I _{CP}	1ms	60	A
		-I _c		30	A
	Collector Power Dissipation	P _c	1 device	120	W
Brake	Collector-Emitter Voltage	V _{CEs}		600	V
	Gate-Emitter Voltage	V _{GEs}		±20	V
	Collector Current	I _c	Continuous	30	A
		I _{CP}	1ms	60	A
	Collector power Dissipation	P _c	1 device	120	W
	Repetitive peak Reverse Voltage	V _{RRM}		600	V
	Average Forward Current	I _{F(AV)}		1	A
	Surge Current	I _{FSM}	10ms	50	A
Converter	Repetitive Peak Reverse Voltage	V _{RRM}		800	V
	Non-Repetitive Peak Reverse Voltage	V _{RSM}		900	V
	Average Output Current	I _o	50Hz/60Hz sine wave	50	A
	Surge Current (Non-Repetitive)	I _{FSM}	Tj=150°C, 10ms	350	A
	I ² t (Non-Repetitive)		Tj=150°C, 10ms	648	A ² s
Operating Junction Temperature	Tj		+ 150	°C	
Storage Temperature	Tstg		-40 ~ +125	°C	
Isolation Voltage	Viso	AC : 1 minute	AC 2500	V	
Mounting Screw Torque (*1)			1.7	N · m	

Note : (*1) Recommendable Value : 1.3 ~ 1.7 N · m (M4)

This material and the information herein is the property of Fuji Electric Co. Ltd. They shall be neither reproduced, copied, lent, or disclosed in any way whatsoever for the use of any third party, nor used for the manufacturing purposes without the express written consent of Fuji Electric Co., Ltd.

Fuji Electric Co., Ltd.

DWGNO.

MS6M0255

4/10

H04-004-03

4. Electrical Characteristics (Tj=25°C unless without specified)

Characteristics		Symbols	Conditions	min.	max.	Units
Inverter	Zero gate voltage collector current	I_{CES}	$V_{CE} = 600V$ $V_{GE} = 0V$		1.0	mA
	Gate-emitter leakage current	I_{GES}	$V_{CE} = 0V$ $V_{GE} = \pm 20V$		20	μA
	Gate-emitter threshold voltage	$V_{GE(th)}$	$V_{CE} = 20V$ $I_C = 30mA$	4.5	7.5	V
	Collector-emitter saturation Voltage	$V_{CE(sat)}$	$V_{CE} = 15V$ $I_C = 30A$		2.8	V
	Collector-Emitter Voltage	$-V_{CE}$	$-I_C = 30A$		3.0	
	Input capacitance	C_{ies}	$V_{GE} = 0V$ $V_{CE} = 10V$ $f = 1MHz$		1980 (typ.)	pF
	Switching Time	t_{on}	$V_{CC} = 300V$ $I_C = 30A$ $V_{GE} = \pm 15V$ $R_G = 82\Omega$		1.2	μS
		t_r			0.6	
		t_{off}			1.0	
		t_f			0.35	
Reverse Recovery Time of FRD	t_{rr}	$I_F = 30A$		300	ns	
Brake	Zero gate voltage collector current	I_{CES}	$V_{CES} = 600V$ $V_{GE} = 0V$		1.0	mA
	Gate-emitter leakage current	I_{GES}	$V_{CE} = 0V$ $V_{GE} = \pm 20V$		100	nA
	Collector-emitter Saturation Voltage	$V_{CE(sat)}$	$I_C = 30A$ $V_{CE} = 15V$		2.8	V
	Switching Time	t_{on}	$V_{CC} = 300V$ $I_C = 30A$ $V_{GE} = \pm 15V$ $R_G = 82\Omega$		0.8	μS
		t_r			0.6	
		t_{off}			1.0	
		t_f			0.35	
Reverse Current	I_{RRM}	$V_R = 600V$		1	mA	
Reverse Recovery Time	t_{rr}			600	ns	

This material and the information herein is the property of Fuji Electric Co., Ltd. They shall be neither reproduced, copied, lent, or disclosed in any way whatsoever for the use of any third party nor used for the manufacturing purposes without the express written consent of Fuji Electric Co., Ltd.

Fuji Electric Co., Ltd.

DWGNO.

MS6M0255

5/10

H04-004-03

Characteristics		Symbols	Conditions	min.	max.	Units
Converter	Forward Voltage	V_{FM}	$I_F = 50A$		1.55	V
	Reverse Current	I_{RRM}	$V_R = 800V$		1	mA

5. Thermal Characteristics

Characteristics	Symbols	Conditions	min.	max.	Units
Thermal Resistance (1 device)	$R_{th(j-c)}$	Inverter IGBT		1.04	$^{\circ}C/W$
		Inverter FRD		2.22	
		Brake IGBT		1.04	
		Converter Diode		2.1	
Contact Thermal Resistance	$R_{th(c-f)}$	With Thermal Compound		(typ) 0.05	

This material and the information herein is the property of Fuji Electric Co. Ltd. They shall be neither reproduced, copied, lent, or disclosed in any way whatsoever for the use of any third party nor used for the manufacturing purposes without the express written consent of Fuji Electric Co., Ltd.

Fuji Electric Co., Ltd.

DWG. NO.

MS6M0255

6/10

H04-004-03

6. Indication on module (モジュール表示)

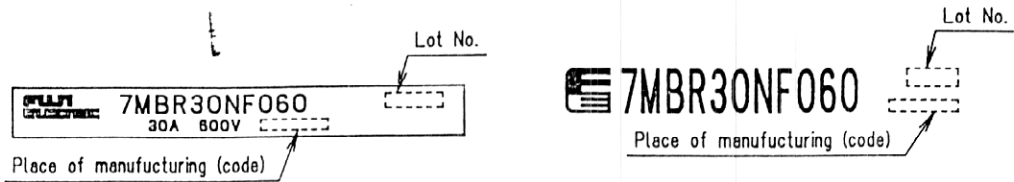

7. Applicable category (適用範囲)

This specification is applied to IGBT module named 7MBR30NF060.
 本納入仕様書は、IGBTモジュール 7MBR30NF060 に適用する。

8. UL recognition (UL承認)

This product is recognized by Underwriters Laboratories Inc., the file No. is E82988.
 本製品は、ファイルNo. E 8 2 9 8 8 にてULより承認されている。

9. Storage and transportation notes (保管、運搬上の注意事項)

- The IGBT module should be stored at a standard temperature of 5 to 35°C and humidity of 45 to 75%.
 常温保存が望ましい。(5~35°C、45~75%)
- Store modules in a place with few temperature changes in order to avoid condensation on the module surface.
 急激な温度変化の無きこと。(モジュール表面が結露しないこと)
- Avoid exposure to corrosive gases and dust.
 腐蝕性ガスの発生場所、塵埃の多い場所は避けること。
- Avoid excessive external force on the module.
 製品に荷重がかからないように十分注意すること。
- Store modules with unprocessed terminals.
 モジュールの端子は未加工の状態での保管すること。
- Do not drop or otherwise shock the modules when transporting.
 製品の運搬時に衝撃を与えたり、落下させたりしないこと。

This material and the information herein is the property of Fuji Electric Co. Ltd. They shall be neither reproduced, copied, lent, or disclosed in any way whatsoever for the use of any third party nor used for the manufacturing purposes without the express written consent of Fuji Electric Co. Ltd.

This material and the information herein is the property of Fuji Electric Co. Ltd. They shall be neither reproduced, copied, lent, or disclosed in any way whatsoever for the use of any third party nor used for the manufacturing purposes without the express written consent of Fuji Electric Co., Ltd.

Collector current vs. Collector-Emitter voltage
Tj=25°C

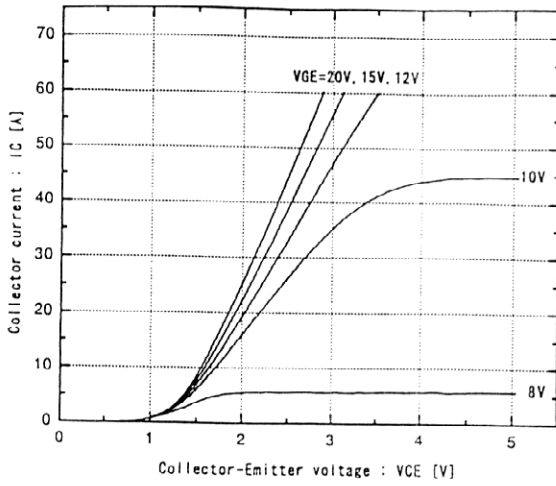

Collector current vs. Collector-Emitter voltage
Tj=125°C

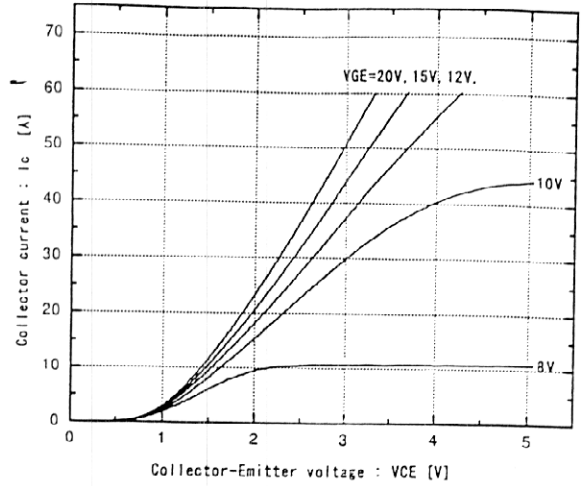

Collector-Emitter vs. Gate-Emitter voltage
Tj=25°C

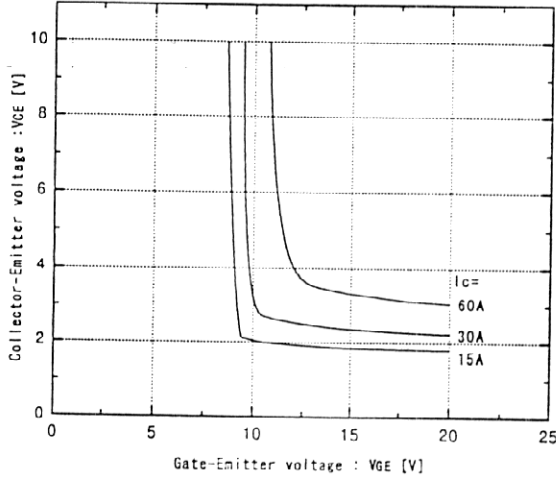

Collector-Emitter vs. Gate-Emitter voltage
Tj=125°C

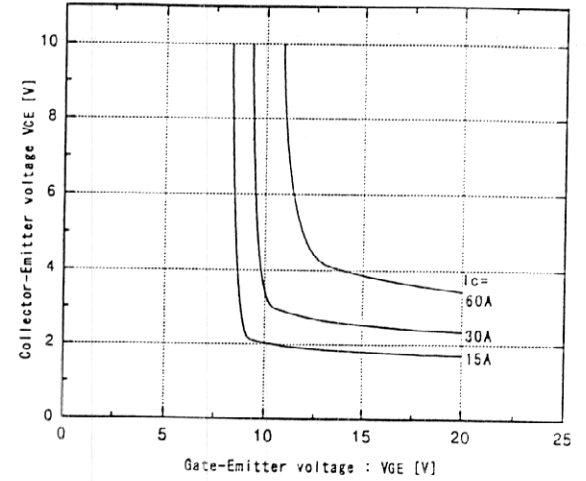

Switching time vs. Collector current
Vcc=300V, RG=82Ω, VGE=±15V, Tj=25°C

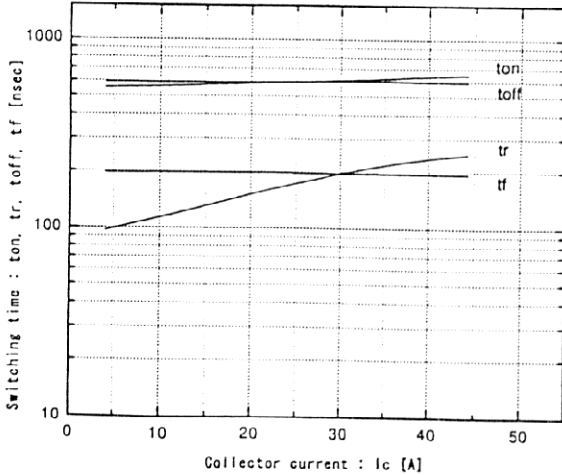

Switching time vs. Collector current
Vcc=300V, RG=82Ω, VGE=±15V, Tj=125°C

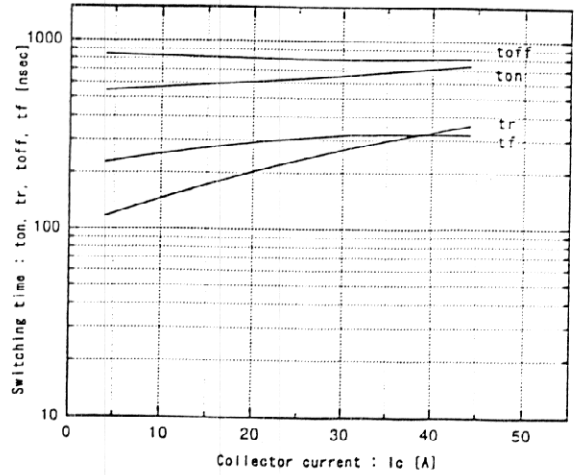

Fuji Electric Co., Ltd.

DWG. NO.

MS6M0255

8/10

This material and the information herein is the property of Fuji Electric Co., Ltd. They shall be neither reproduced, copied, lent, or disclosed in any way whatsoever for the use of any third party nor used for the manufacturing purposes without the express written consent of Fuji Electric Co., Ltd.

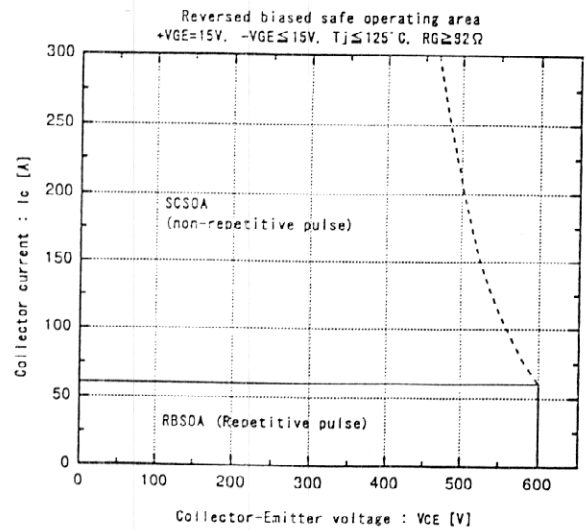
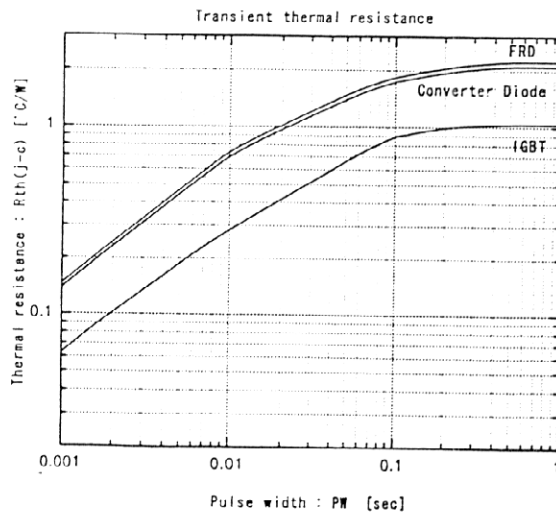
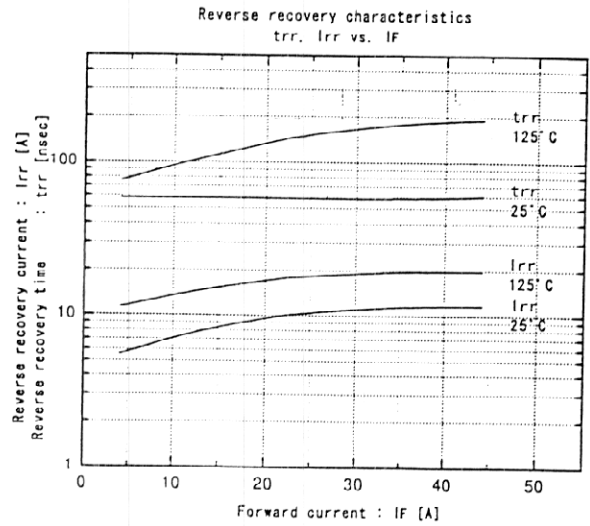
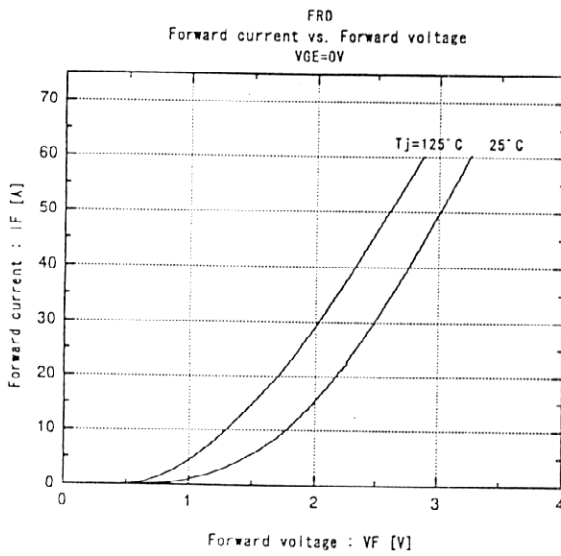
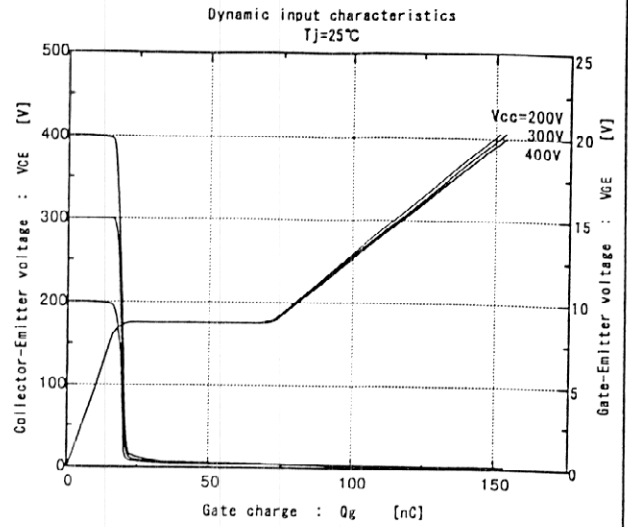
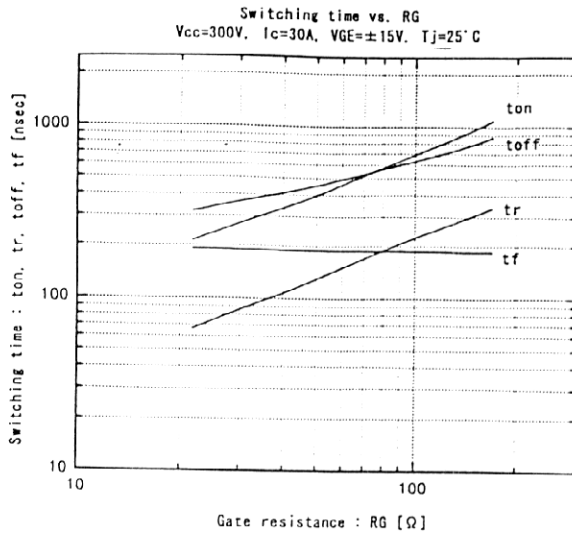

Fuji Electric Co., Ltd.

DWG. NO.

MS6M0255

9/10

H04-004-03

This material and the information herein is the property of Fuji Electric Co., Ltd. They shall be neither reproduced, copied, lent, or disclosed in any way whatsoever for the use of any third party nor used for the manufacturing purposes without the express written consent of Fuji Electric Co., Ltd.

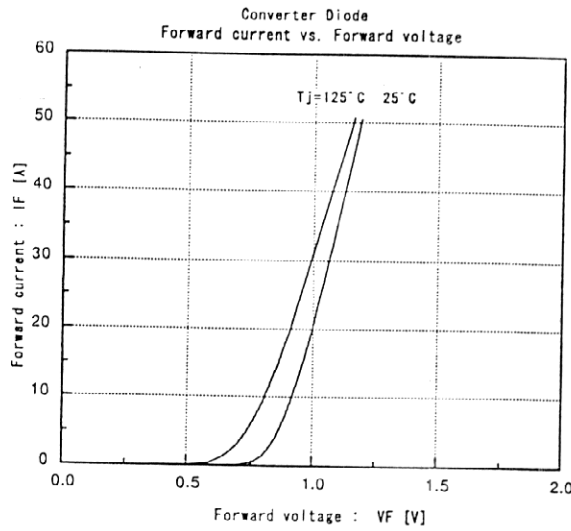
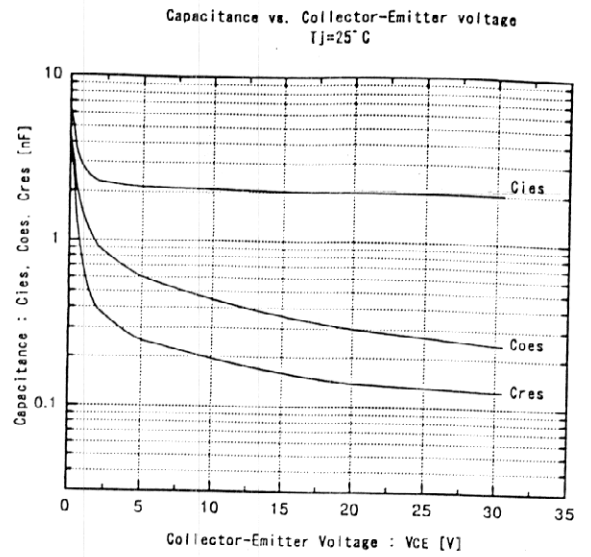
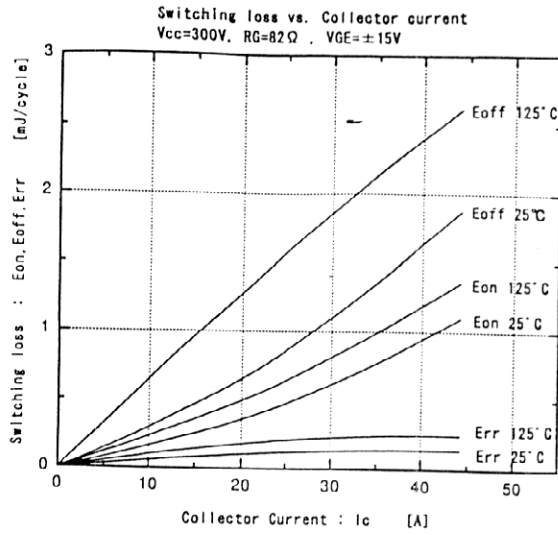

Fuji Electric Co., Ltd.

DWG. NO.

MS6M0255

10/10

H04-004-03