

# DATA SHEET

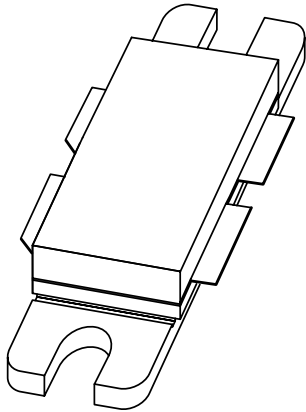

## **BLF861A** UHF power LDMOS transistor

Preliminary specification

2000 Aug 04

## UHF power LDMOS transistor

BLF861A

## FEATURES

- High power gain
- Easy power control
- Excellent ruggedness
- Designed to withstand abrupt load mismatch errors
- Source on underside eliminates DC isolators; reducing common mode inductance
- Designed for broadband operation (UHF band)
- Internal input and output matching for high gain and optimum broadband operation.

## APPLICATIONS

- Communication transmitter applications in the UHF frequency range.

## DESCRIPTION

Silicon N-channel enhancement mode lateral D-MOS push-pull transistor in a SOT540A package with ceramic cap. The common source is connected to the mounting flange.

## PINNING - SOT540A

PIN	DESCRIPTION
1	drain 1
2	drain 2
3	gate 1
4	gate 2
5	source connected to flange

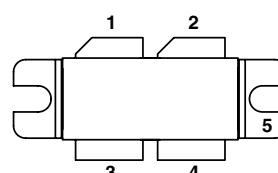

Top view

MBK777

Fig.1 Simplified outline.

## QUICK REFERENCE DATA

RF performance at  $T_h = 25\text{ °C}$  in a common source 860 MHz test circuit.

MODE OF OPERATION	f (MHz)	$V_{DS}$ (V)	$P_L$ (W)	$G_p$ (dB)	$\eta_D$ (%)	$\Delta G_p$ (dB)
CW, class-AB	860	32	150	>13.5 typ. 14.5	>50	$\leq 1$
PAL BG (TV); class-AB	860 (ch 69)	32	>150 typ. 170 (peak sync)	>14	>40	note 1

## Note

1. Sync compression: input sync  $\geq 33\%$ ; output sync 27%.

## LIMITING VALUES

In accordance with the Absolute Maximum Rating System (IEC 60134).

SYMBOL	PARAMETER	CONDITIONS	MIN.	MAX.	UNIT
$V_{DS}$	drain-source voltage		–	65	V
$V_{GS}$	gate-source voltage		–	$\pm 15$	V
$I_D$	drain current (DC)		–	18	A
$P_{tot}$	total power dissipation	$T_{mb} \leq 25\text{ °C}$	–	318	W
$T_{stg}$	storage temperature		–65	+150	$^{\circ}\text{C}$
$T_j$	junction temperature		–	200	$^{\circ}\text{C}$

UHF power LDMOS transistor

BLF861A

**THERMAL CHARACTERISTICS**

SYMBOL	PARAMETER	CONDITIONS	VALUE	UNIT
$R_{th\ j-mb}$	thermal resistance from junction to mounting base	$T_{mb} = 25\text{ °C}; P_{tot} = 318\text{ W}$	0.55	K/W
$R_{th\ mb-h}$	thermal resistance from mounting base to heatsink		0.2	K/W

**CHARACTERISTICS**

$T_j = 25\text{ °C}$ ; per section; unless otherwise specified.

SYMBOL	PARAMETER	CONDITIONS	MIN.	TYP.	MAX.	UNIT
$V_{(BR)DSS}$	drain-source breakdown voltage	$V_{GS} = 0; I_D = 1.5\text{ mA}$	65	–	–	V
$V_{GSth}$	gate-source threshold voltage	$V_{DS} = 10\text{ V}; I_D = 150\text{ mA}$	4	–	5.5	V
$I_{DSS}$	drain-source leakage current	$V_{GS} = 0; V_{DS} = 32\text{ V}$	–	–	2.2	$\mu\text{A}$
$I_{DSX}$	drain cut-off current	$V_{GS} = V_{GSth} + 9\text{ V}; V_{DS} = 10\text{ V}$	18	–	–	A
$I_{GSS}$	gate leakage current	$V_{GS} = \pm 15\text{ V}; V_{DS} = 0$	–	–	25	nA
$g_{fs}$	forward transconductance	$V_{DS} = 10\text{ V}; I_D = 4\text{ A}$	–	4	–	S
$R_{DSon}$	drain-source on-state resistance	$V_{GS} = V_{GSth} + 9\text{ V}; I_D = 4\text{ A}$	–	160	–	$\text{m}\Omega$
$C_{iss}$	input capacitance	$V_{GS} = 0; V_{DS} = 32\text{ V}; f = 1\text{ MHz}^{(1)}$	–	82	–	pF
$C_{oss}$	output capacitance	$V_{GS} = 0; V_{DS} = 32\text{ V}; f = 1\text{ MHz}^{(1)}$	–	40	–	pF
$C_{rss}$	feedback capacitance	$V_{GS} = 0; V_{DS} = 32\text{ V}; f = 1\text{ MHz}^{(1)}$	–	6	–	pF

**Note**

1. Capacitance values without internal matching.

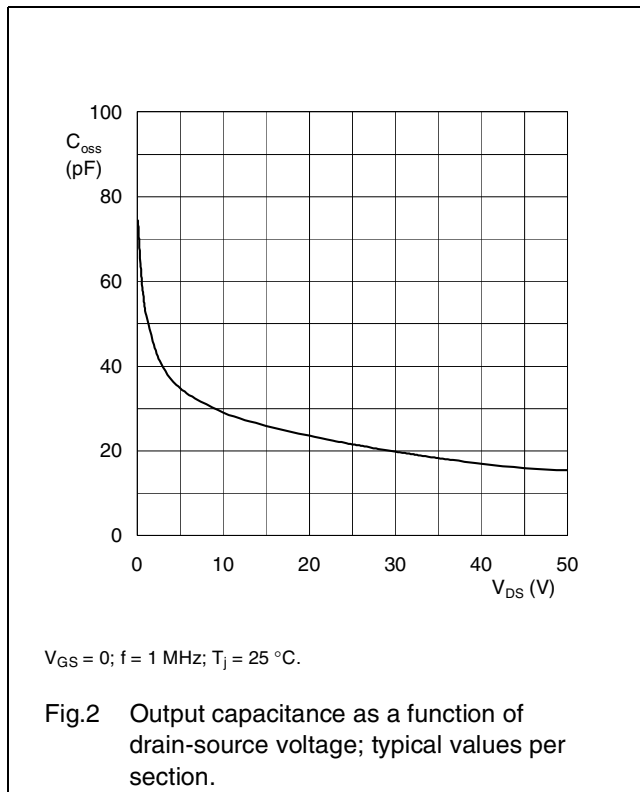

UHF power LDMOS transistor

BLF861A

APPLICATION INFORMATION

RF performance in a common source 860 MHz test circuit.  $T_h = 25\text{ }^\circ\text{C}$ ;  $R_{th\text{ mb-h}} = 0.15\text{ K/W}$ ; unless otherwise specified.

MODE OF OPERATION	f (MHz)	V <sub>DS</sub> (V)	I <sub>DQ</sub> (A)	P <sub>L</sub> (W)	G <sub>p</sub> (dB)	$\eta_D$ (%)	d <sub>Im</sub> (dBc)	$\Delta G_p$ (dB)
CW; class-AB	860	32	1	150	>13.5 typ. 14.5	>50	–	≤1
2-tone; class-AB	f <sub>1</sub> = 860 f <sub>2</sub> = 860.1	32	1	150 (PEP)	>14	>40	≤–25	–
PAL BG (TV); class-AB	860 (ch 69)	32	1	> 150 typ. 170 (peak sync)	>14	>40	–	note 1

Note

1. Sync compression: input sync ≥ 33%; output sync 27% measured in 860 MHz test circuit.

Ruggedness in class-AB operation

The BLF861A is capable of withstanding a load mismatch corresponding to VSWR = 10 : 1 through all phases under the following conditions: V<sub>DS</sub> = 32 V; f = 860 MHz at rated load power.

The BLF861A is an improved version of the BLF861 on ruggedness and is capable to withstand abrupt source or load mismatch errors under the nominal power condition.

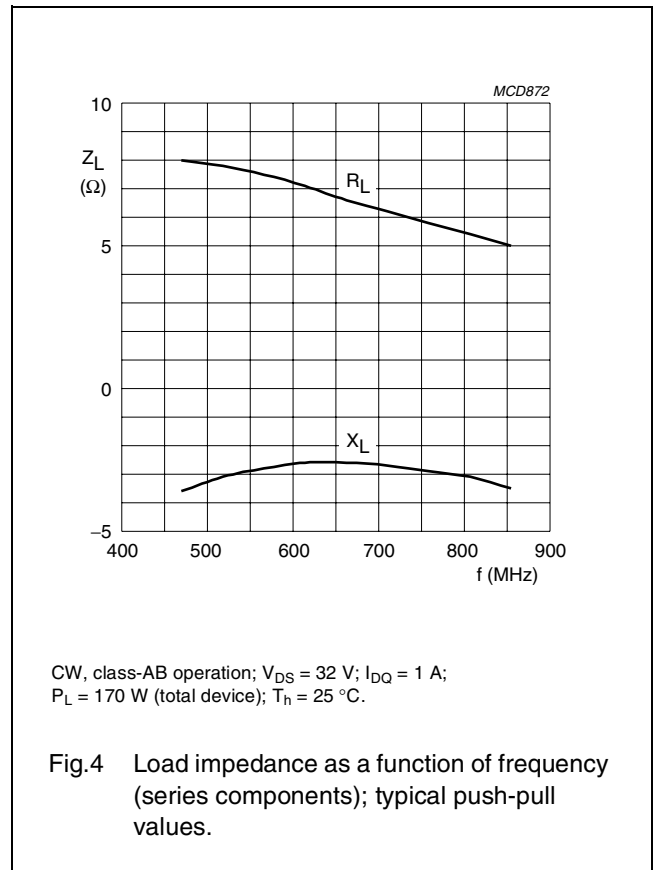
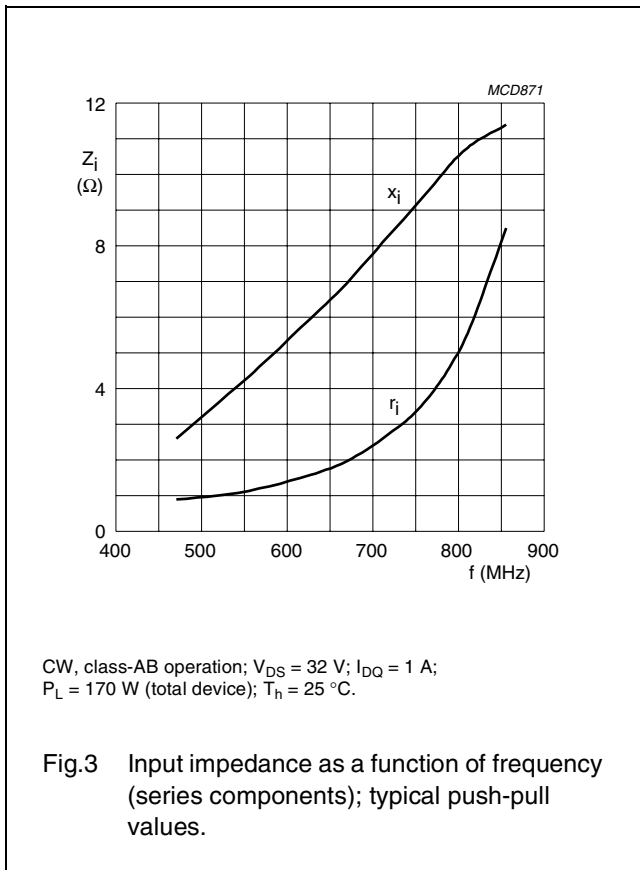

UHF power LDMOS transistor

BLF861A

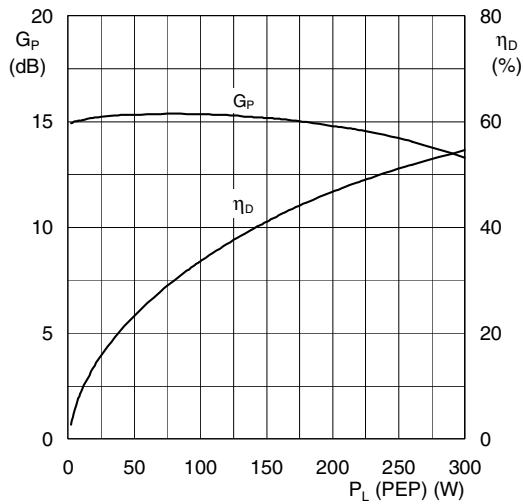

$T_h = 25\text{ }^\circ\text{C}$ ;  $V_{DS} = 32\text{ V}$ ;  $I_{DQ} = 1\text{ A}$ .  
 2-tone:  $f_1 = 860\text{ MHz}$  (-6 dB);  $f_2 = 860.1\text{ MHz}$  (-6 dB)  
 measured in 860 MHz test circuit.

Fig.5 Power gain and drain efficiency as functions of peak envelope load power; typical values.

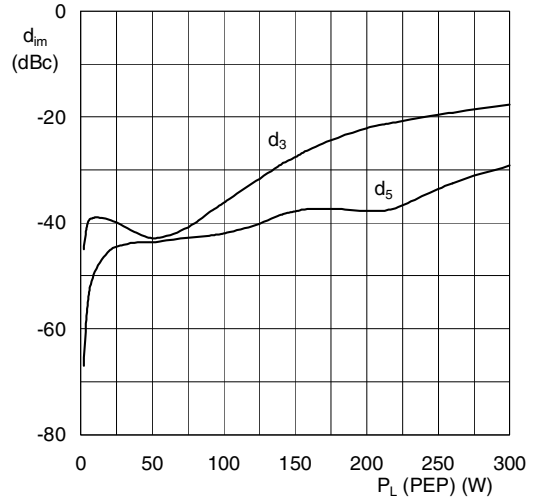

$T_h = 25\text{ }^\circ\text{C}$ ;  $V_{DS} = 32\text{ V}$ ;  $I_{DQ} = 1\text{ A}$ .  
 2-tone:  $f_1 = 860\text{ MHz}$  (-6 dB);  $f_2 = 860.1\text{ MHz}$  (-6 dB)  
 measured in 860 MHz test circuit.

Fig.6 Intermodulation distortion as a function of peak envelope output power; typical values.

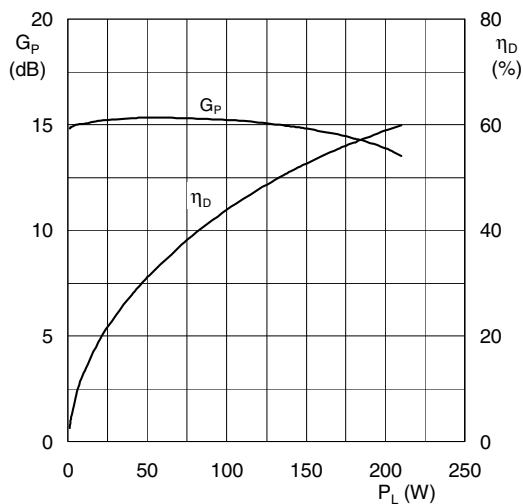

$T_h = 25\text{ }^\circ\text{C}$ ;  $V_{DS} = 32\text{ V}$ ;  $I_{DQ} = 1\text{ A}$ ; CW, class-AB;  $f = 860\text{ MHz}$ ;  
 measured in 860 MHz test circuit.

Fig.7 Power gain and drain efficiency as functions of load power; typical values.

UHF power LDMOS transistor

BLF861A

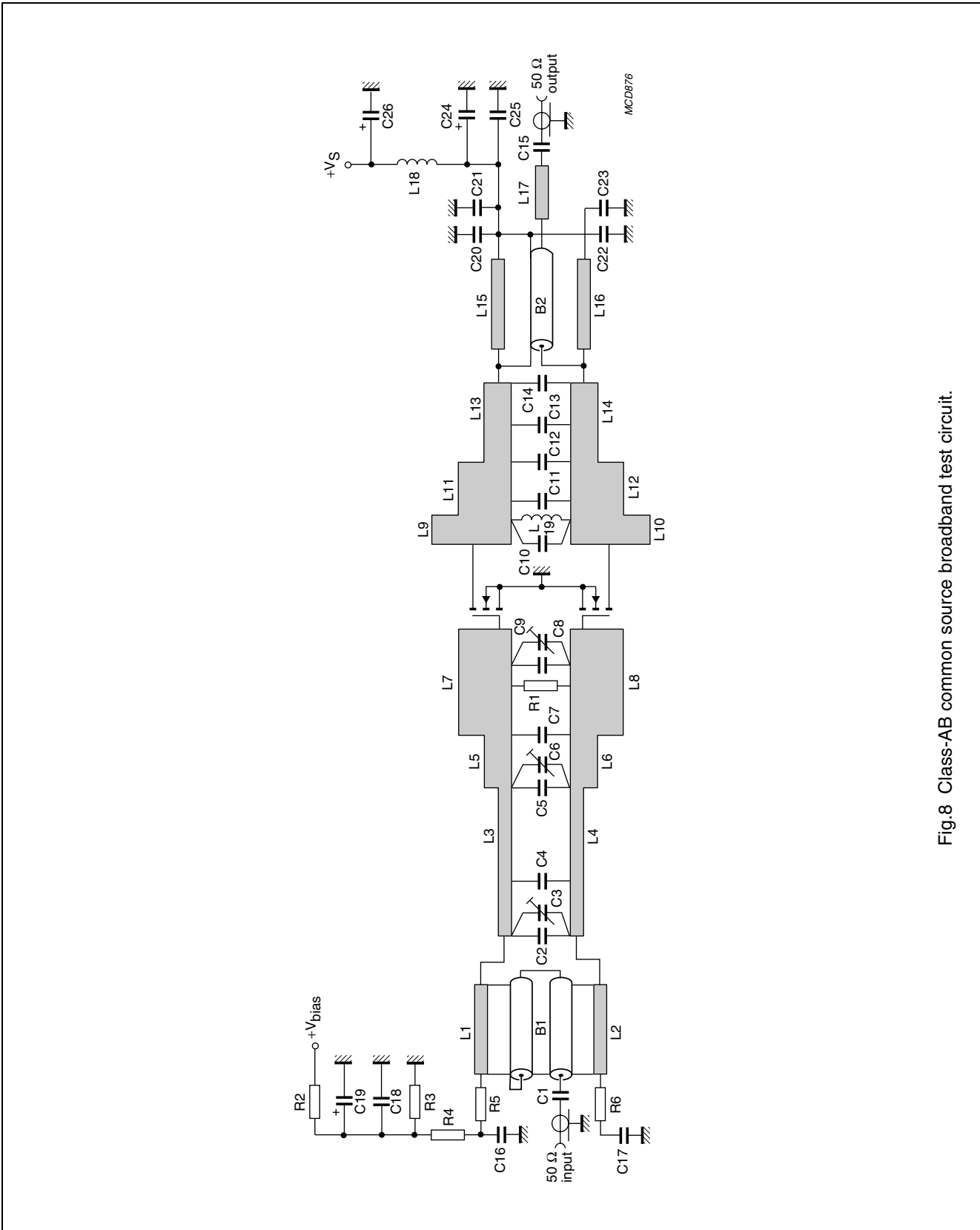

Fig.8 Class-AB common source broadband test circuit.

## UHF power LDMOS transistor

BLF861A

## List of components class-AB broadband test circuit (see Figs 8 and 9)

COMPONENT	DESCRIPTION	VALUE	DIMENSIONS	CATALOGUE No.
C1	multilayer ceramic chip capacitor; note 1	20 pF		
C2	multilayer ceramic chip capacitor; note 1	4.3 pF		
C3, C6, C9	tekelec trimmer	0.6 to 4.5 pF		
C4	multilayer ceramic chip capacitor; note 1	9.1 pF		
C5	multilayer ceramic chip capacitor; note 1	10 pF		
C7	multilayer ceramic chip capacitor; note 1	5.1 pF		
C8	multilayer ceramic chip capacitor; note 1	13 pF		
C10, C11	multilayer ceramic chip capacitor; note 2	8.2 pF		
C12, C13	multilayer ceramic chip capacitor; note 2	6.8 pF		
C14	multilayer ceramic chip capacitor; note 3	1 pF		
C15	multilayer ceramic chip capacitor; note 3	20 pF		
C16, C17	multilayer ceramic chip capacitor	1 nF		
C18	multilayer ceramic chip capacitor	100 nF		
C19, C26	multilayer ceramic chip capacitor	100 $\mu$ F		
C20, C21, C22, C23	multilayer ceramic chip capacitor; note 2	100 pF		
C24	electrolytic capacitor	1000 $\mu$ F		
C25	multilayer ceramic chip capacitor	1 $\mu$ F		2222 595 16754
L1, L2	stripline; note 4		30.6 $\times$ 2.4 mm	
L3, L4	stripline; note 4		28 $\times$ 2.4 mm	
L5, L6	stripline; note 4		10 $\times$ 5 mm	
L7, L8	stripline; note 4		20 $\times$ 10 mm	
L9, L10	stripline; note 4		5.5 $\times$ 15 mm	
L11, L12	stripline; note 4		10 $\times$ 10 mm	
L13, L14	stripline; note 4		15 $\times$ 5 mm	
L15, L16	stripline; note 4		48.5 $\times$ 2.4 mm	
L17	stripline; note 4		10 $\times$ 2.4 mm	
L18	ferrite			
L19	wire inductor (hairpin)		length = 17 mm	
B1	semi rigid coax balun UT70-25	Z = 25 $\Omega$ $\pm$ 1.5 $\Omega$	70 mm	
B2	semi rigid coax balun UT70-25	Z = 25 $\Omega$ $\pm$ 1.5 $\Omega$	48.5 mm	

## UHF power LDMOS transistor

BLF861A

COMPONENT	DESCRIPTION	VALUE	DIMENSIONS	CATALOGUE No.
R1	resistor	33 $\Omega$		
R2	resistor	1 k $\Omega$		
R3	resistor	100 k $\Omega$		
R4	resistor	100 $\Omega$		
R5, R6	SMD resistor	3.9 $\Omega$		

**Notes**

1. American Technical Ceramics type 100A or capacitor of same quality.
2. American Technical Ceramics type 180R or capacitor of same quality.
3. American Technical ceramics type 100B or capacitor of same quality.
4. The striplines are on a double copper-clad printed-circuit board: Rogers 5880 ( $\epsilon_r = 2.2$ ); thickness 0.79 mm.



UHF power LDMOS transistor

BLF861A

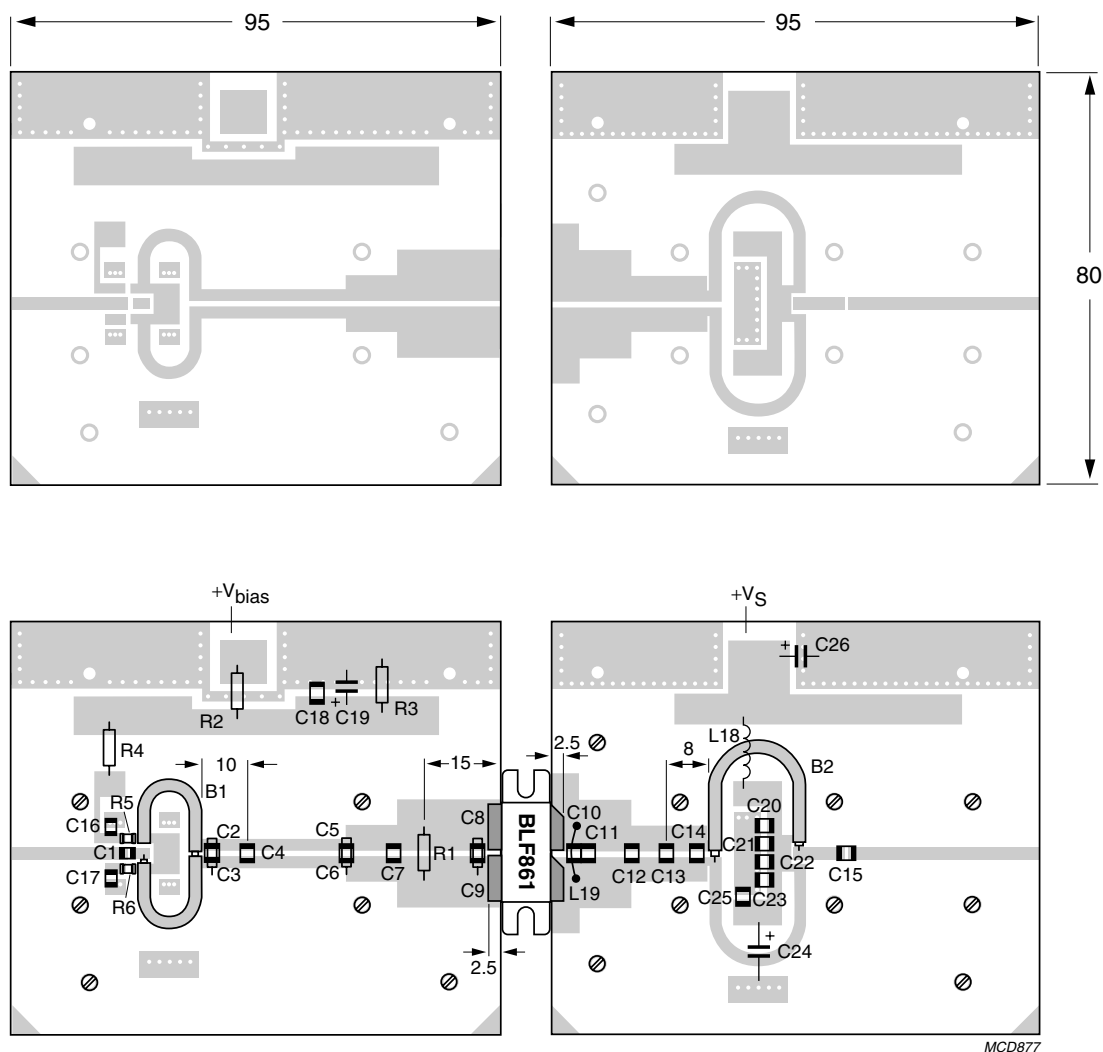

MCD877

Dimensions in mm.

The components are situated on one side of the Rogers 5880 printed-circuit board, the other side is unetched and serves as a ground plane. Earth connections from the component side to the ground plane are made by through metallization.

Fig.9 Printed-circuit board and component layout for class-AB broadband test circuit.

UHF power LDMOS transistor

BLF861A

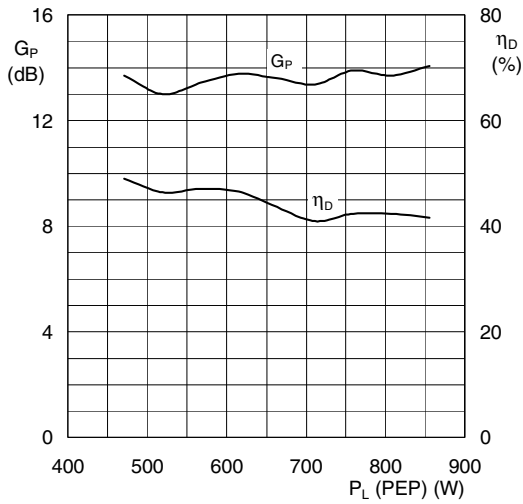

$T_h = 25\text{ }^\circ\text{C}$ ;  $V_{CE} = 32\text{ V}$ ;  $I_{DQ} = 1\text{ A}$ ; PAL BG signal (TV);  
sync compression: input 33%, output 27%;  
measured in broadband test circuit.

Fig.10 Power gain and drain efficiency as functions of frequency; typical values.

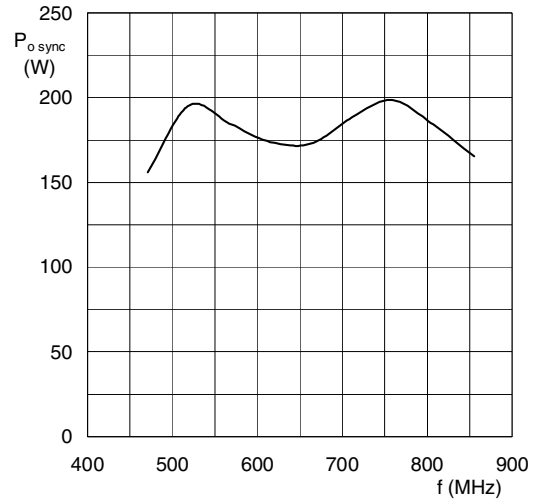

$T_h = 25\text{ }^\circ\text{C}$ ;  $V_{CE} = 32\text{ V}$ ;  $I_{DQ} = 1\text{ A}$ ; PAL BG signal (TV);  
sync compression: input 33%, output 27%;  
measured in broadband test circuit.

Fig.11 Peak envelope sync power as a function of frequency; typical values.

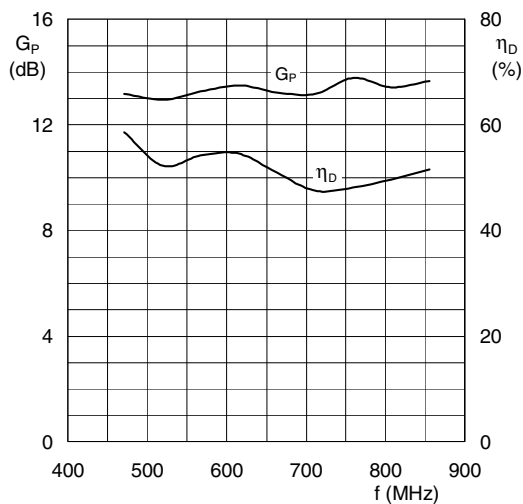

$T_h = 25\text{ }^\circ\text{C}$ ;  $V_{DS} = 32\text{ V}$ ;  $I_{DQ} = 1\text{ A}$ ; CW, class-AB operation;  
 $P_L = 150\text{ W}$ ; measured in broadband test circuit.

Fig.12 Power gain and drain efficiency as functions of frequency; typical values.

UHF power LDMOS transistor

BLF861A

PACKAGE OUTLINE

Flanged balanced LDMOST ceramic package; 2 mounting holes; 4 leads

SOT540A

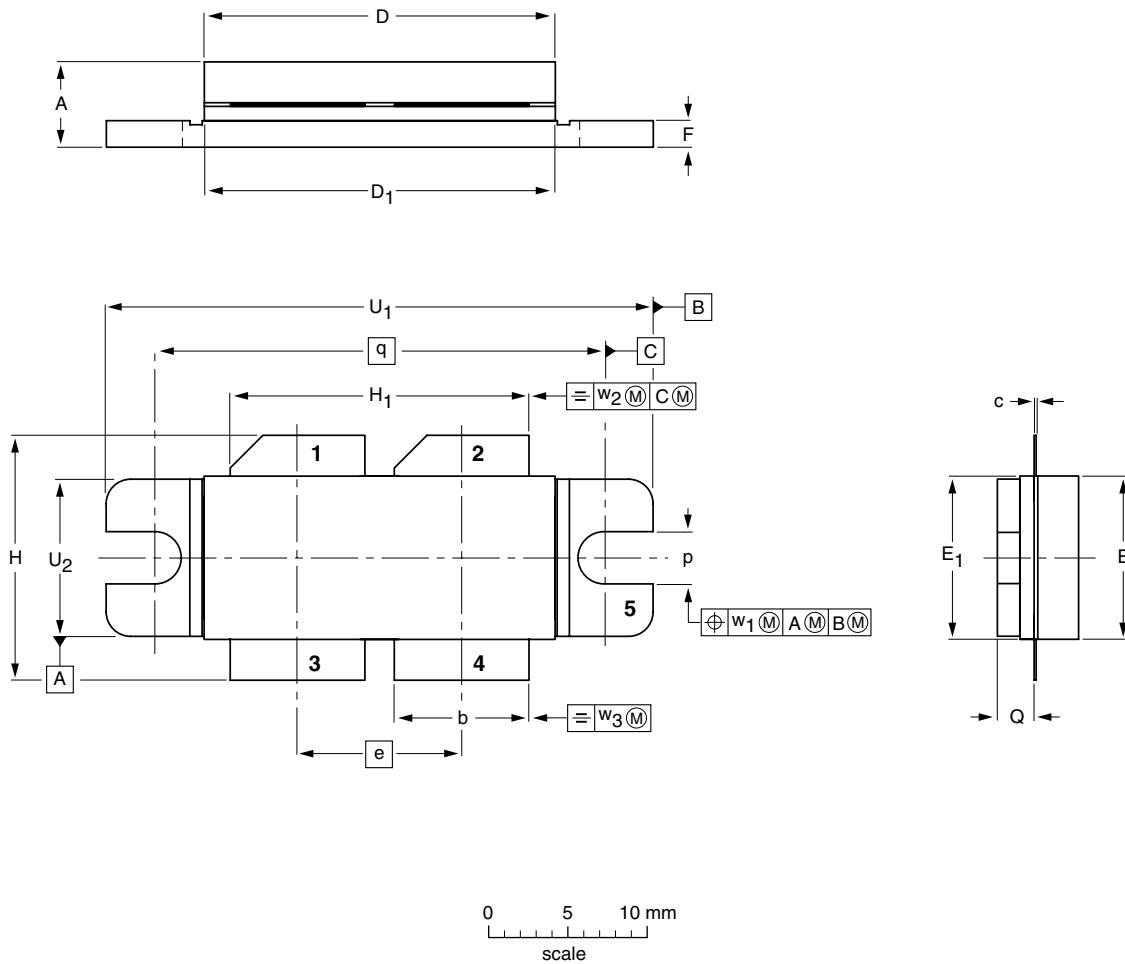

DIMENSIONS (millimetre dimensions are derived from the original inch dimensions)

UNIT	A	b	c	D	D <sub>1</sub>	e	E	E <sub>1</sub>	F	H	H <sub>1</sub>	p	Q	q	U <sub>1</sub>	U <sub>2</sub>	w <sub>1</sub>	w <sub>2</sub>	w <sub>3</sub>
mm	5.77 5.00	8.51 8.26	0.15 0.10	22.05 21.64	22.05 21.64	10.21	10.26 10.06	10.31 10.01	1.78 1.52	15.75 14.73	18.72 18.47	3.38 3.12	2.72 2.46	27.94	34.16 33.91	9.91 9.65	0.25	0.51	0.25
inches	0.227 0.197	0.335 0.325	0.006 0.004	0.868 0.852	0.868 0.852	0.402	0.404 0.396	0.406 0.394	0.070 0.060	0.620 0.580	0.737 0.727	0.133 0.123	0.107 0.097	1.100	1.345 1.335	0.390 0.380	0.010	0.020	0.010

OUTLINE VERSION	REFERENCES				EUROPEAN PROJECTION	ISSUE DATE
	IEC	JEDEC	EIAJ			
SOT540A						99-08-27 99-12-28

## UHF power LDMOS transistor

BLF861A

## DATA SHEET STATUS

DATA SHEET STATUS	PRODUCT STATUS	DEFINITIONS <sup>(1)</sup>
Objective specification	Development	This data sheet contains the design target or goal specifications for product development. Specification may change in any manner without notice.
Preliminary specification	Qualification	This data sheet contains preliminary data, and supplementary data will be published at a later date. Philips Semiconductors reserves the right to make changes at any time without notice in order to improve design and supply the best possible product.
Product specification	Production	This data sheet contains final specifications. Philips Semiconductors reserves the right to make changes at any time without notice in order to improve design and supply the best possible product.

## Note

1. Please consult the most recently issued data sheet before initiating or completing a design.

## DEFINITIONS

**Short-form specification** — The data in a short-form specification is extracted from a full data sheet with the same type number and title. For detailed information see the relevant data sheet or data handbook.

**Limiting values definition** — Limiting values given are in accordance with the Absolute Maximum Rating System (IEC 60134). Stress above one or more of the limiting values may cause permanent damage to the device. These are stress ratings only and operation of the device at these or at any other conditions above those given in the Characteristics sections of the specification is not implied. Exposure to limiting values for extended periods may affect device reliability.

**Application information** — Applications that are described herein for any of these products are for illustrative purposes only. Philips Semiconductors make no representation or warranty that such applications will be suitable for the specified use without further testing or modification.

## DISCLAIMERS

**Life support applications** — These products are not designed for use in life support appliances, devices, or systems where malfunction of these products can reasonably be expected to result in personal injury. Philips Semiconductors customers using or selling these products for use in such applications do so at their own risk and agree to fully indemnify Philips Semiconductors for any damages resulting from such application.

**Right to make changes** — Philips Semiconductors reserves the right to make changes, without notice, in the products, including circuits, standard cells, and/or software, described or contained herein in order to improve design and/or performance. Philips Semiconductors assumes no responsibility or liability for the use of any of these products, conveys no licence or title under any patent, copyright, or mask work right to these products, and makes no representations or warranties that these products are free from patent, copyright, or mask work right infringement, unless otherwise specified.

## CAUTION

This product is supplied in anti-static packing to prevent damage caused by electrostatic discharge during transport and handling. For further information, refer to Philips specs.: SNW-EQ-608, SNW-FQ-302A and SNW-FQ-302B.

# Philips Semiconductors – a worldwide company

**Argentina:** see South America

**Australia:** 3 Figtree Drive, HOMEBUSH, NSW 2140,  
Tel. +61 2 9704 8141, Fax. +61 2 9704 8139

**Austria:** Computerstr. 6, A-1101 WIEN, P.O. Box 213,  
Tel. +43 1 60 101 1248, Fax. +43 1 60 101 1210

**Belarus:** Hotel Minsk Business Center, Bld. 3, r. 1211, Volodarski Str. 6,  
220050 MINSK, Tel. +375 172 20 0733, Fax. +375 172 20 0773

**Belgium:** see The Netherlands

**Brazil:** see South America

**Bulgaria:** Philips Bulgaria Ltd., Energoproject, 15th floor,  
51 James Bourchier Blvd., 1407 SOFIA,  
Tel. +359 2 68 9211, Fax. +359 2 68 9102

**Canada:** PHILIPS SEMICONDUCTORS/COMPONENTS,  
Tel. +1 800 234 7381, Fax. +1 800 943 0087

**China/Hong Kong:** 501 Hong Kong Industrial Technology Centre,  
72 Tat Chee Avenue, Kowloon Tong, HONG KONG,  
Tel. +852 2319 7888, Fax. +852 2319 7700

**Colombia:** see South America

**Czech Republic:** see Austria

**Denmark:** Sydhavnsgade 23, 1780 COPENHAGEN V,  
Tel. +45 33 29 3333, Fax. +45 33 29 3905

**Finland:** Sinikalliontie 3, FIN-02630 ESPOO,  
Tel. +358 9 615 800, Fax. +358 9 6158 0920

**France:** 51 Rue Carnot, BP317, 92156 SURESNES Cedex,  
Tel. +33 1 4099 6161, Fax. +33 1 4099 6427

**Germany:** Hammerbrookstraße 69, D-20097 HAMBURG,  
Tel. +49 40 2353 60, Fax. +49 40 2353 6300

**Hungary:** see Austria

**India:** Philips INDIA Ltd, Band Box Building, 2nd floor,  
254-D, Dr. Annie Besant Road, Worli, MUMBAI 400 025,  
Tel. +91 22 493 8541, Fax. +91 22 493 0966

**Indonesia:** PT Philips Development Corporation, Semiconductors Division,  
Gedung Philips, Jl. Buncit Raya Kav.99-100, JAKARTA 12510,  
Tel. +62 21 794 0040 ext. 2501, Fax. +62 21 794 0080

**Ireland:** Newstead, Clonskeagh, DUBLIN 14,  
Tel. +353 1 7640 000, Fax. +353 1 7640 200

**Israel:** RAPAC Electronics, 7 Kehilat Saloniki St, PO Box 18053,  
TEL AVIV 61180, Tel. +972 3 645 0444, Fax. +972 3 649 1007

**Italy:** PHILIPS SEMICONDUCTORS, Via Casati, 23 - 20052 MONZA (MI),  
Tel. +39 039 203 6838, Fax +39 039 203 6800

**Japan:** Philips Bldg 13-37, Kohnan 2-chome, Minato-ku,  
TOKYO 108-8507, Tel. +81 3 3740 5130, Fax. +81 3 3740 5057

**Korea:** Philips House, 260-199 Itaewon-dong, Yongsan-ku, SEOUL,  
Tel. +82 2 709 1412, Fax. +82 2 709 1415

**Malaysia:** No. 76 Jalan Universiti, 46200 PETALING JAYA, SELANGOR,  
Tel. +60 3 750 5214, Fax. +60 3 757 4880

**Mexico:** 5900 Gateway East, Suite 200, EL PASO, TEXAS 79905,  
Tel. +9-5 800 234 7381, Fax +9-5 800 943 0087

**Middle East:** see Italy

**Netherlands:** Postbus 90050, 5600 PB EINDHOVEN, Bldg. VB,  
Tel. +31 40 27 82785, Fax. +31 40 27 88399

**New Zealand:** 2 Wagener Place, C.P.O. Box 1041, AUCKLAND,  
Tel. +64 9 849 4160, Fax. +64 9 849 7811

**Norway:** Box 1, Manglerud 0612, OSLO,  
Tel. +47 22 74 8000, Fax. +47 22 74 8341

**Pakistan:** see Singapore

**Philippines:** Philips Semiconductors Philippines Inc.,  
106 Valero St. Salcedo Village, P.O. Box 2108 MCC, MAKATI,  
Metro MANILA, Tel. +63 2 816 6380, Fax. +63 2 817 3474

**Poland:** Al.Jerozolimskie 195 B, 02-222 WARSAW,  
Tel. +48 22 5710 000, Fax. +48 22 5710 001

**Portugal:** see Spain

**Romania:** see Italy

**Russia:** Philips Russia, Ul. Usatcheva 35A, 119048 MOSCOW,  
Tel. +7 095 755 6918, Fax. +7 095 755 6919

**Singapore:** Lorong 1, Toa Payoh, SINGAPORE 319762,  
Tel. +65 350 2538, Fax. +65 251 6500

**Slovakia:** see Austria

**Slovenia:** see Italy

**South Africa:** S.A. PHILIPS Pty Ltd., 195-215 Main Road Martindale,  
2092 JOHANNESBURG, P.O. Box 58088 Newville 2114,  
Tel. +27 11 471 5401, Fax. +27 11 471 5398

**South America:** Al. Vicente Pinzon, 173, 6th floor,  
04547-130 SÃO PAULO, SP, Brazil,  
Tel. +55 11 821 2333, Fax. +55 11 821 2382

**Spain:** Balmes 22, 08007 BARCELONA,  
Tel. +34 93 301 6312, Fax. +34 93 301 4107

**Sweden:** Kottbygatan 7, Akalla, S-16485 STOCKHOLM,  
Tel. +46 8 5985 2000, Fax. +46 8 5985 2745

**Switzerland:** Allmendstrasse 140, CH-8027 ZÜRICH,  
Tel. +41 1 488 2741 Fax. +41 1 488 3263

**Taiwan:** Philips Semiconductors, 5F, No. 96, Chien Kuo N. Rd., Sec. 1,  
TAIPEI, Taiwan Tel. +886 2 2134 2451, Fax. +886 2 2134 2874

**Thailand:** PHILIPS ELECTRONICS (THAILAND) Ltd.,  
60/14 MOO 11, Bangna Trad Road KM. 3, Bagna, BANGKOK 10260,  
Tel. +66 2 361 7910, Fax. +66 2 398 3447

**Turkey:** Yukari Dudullu, Org. San. Blg., 2.Cad. Nr. 28 81260 Umraniye,  
ISTANBUL, Tel. +90 216 522 1500, Fax. +90 216 522 1813

**Ukraine:** PHILIPS UKRAINE, 4 Patrice Lumumba str., Building B, Floor 7,  
252042 KIEV, Tel. +380 44 264 2776, Fax. +380 44 268 0461

**United Kingdom:** Philips Semiconductors Ltd., 276 Bath Road, Hayes,  
MIDDLESEX UB3 5BX, Tel. +44 208 730 5000, Fax. +44 208 754 8421

**United States:** 811 East Arques Avenue, SUNNYVALE, CA 94088-3409,  
Tel. +1 800 234 7381, Fax. +1 800 943 0087

**Uruguay:** see South America

**Vietnam:** see Singapore

**Yugoslavia:** PHILIPS, Trg N. Pasica 5/v, 11000 BEOGRAD,  
Tel. +381 11 3341 299, Fax.+381 11 3342 553

**For all other countries apply to:** Philips Semiconductors,  
Marketing Communications, Building BE-p, P.O. Box 218, 5600 MD EINDHOVEN,  
The Netherlands, Fax. +31 40 27 24825

**Internet:** <http://www.semiconductors.philips.com>

© Philips Electronics N.V. 2000

SCA70

All rights are reserved. Reproduction in whole or in part is prohibited without the prior written consent of the copyright owner.

The information presented in this document does not form part of any quotation or contract, is believed to be accurate and reliable and may be changed without notice. No liability will be accepted by the publisher for any consequence of its use. Publication thereof does not convey nor imply any license under patent- or other industrial or intellectual property rights.

Printed in The Netherlands

613524/09/pp13

Date of release: 2000 Aug 04

Document order number: 9397 750 07376

*Let's make things better.*

**Philips**  
Semiconductors



**PHILIPS**