

MITSUBISHI IGBT MODULES
CM200DU-24F

HIGH POWER SWITCHING USE

CM200DU-24F



- Ic200A
- VCES 1200V
- Insulated Type
- 2-elements in a pack

APPLICATION

General purpose inverters & Servo controls, etc

OUTLINE DRAWING & CIRCUIT DIAGRAM

Dimensions in mm

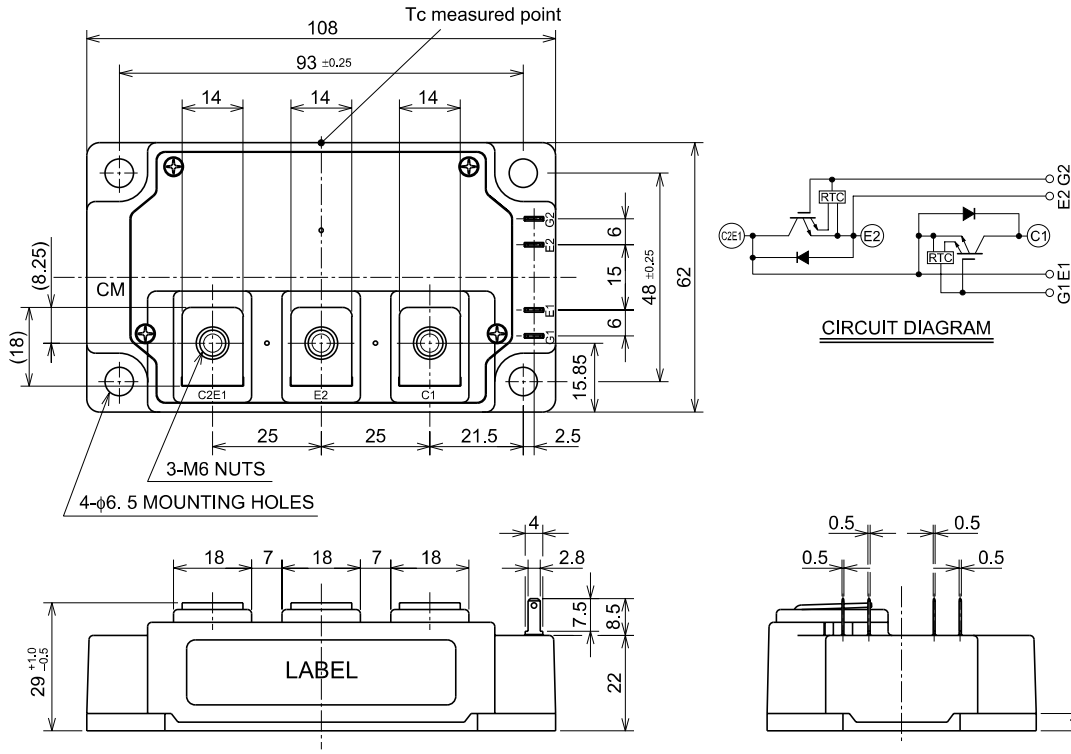

CM200DU-24F

HIGH POWER SWITCHING USE

MAXIMUM RATINGS (T_j = 25°C)

Symbol	Parameter	Conditions	Ratings	Unit
V _{CES}	Collector-emitter voltage	G-E Short	1200	V
V _{GES}	Gate-emitter voltage	C-E Short	±20	V
I _C	Collector current	T _C = 25°C	200	A
I _{CM}		Pulse (Note 2)	400	
I _E (Note 1)	Emitter current	T _C = 25°C	200	A
I _{EM} (Note 1)		Pulse (Note 2)	400	
P _C (Note 3)	Maximum collector dissipation	T _C = 25°C	830	W
T _j	Junction temperature		-40 ~ +150	°C
T _{stg}	Storage temperature		-40 ~ +125	°C
V _{iso}	Isolation voltage	Main terminal to base plate, AC 1 min.	2500	V
—	Torque strength	Main Terminal M6	3.5 ~ 4.5	N • m
		Mounting holes M6	3.5 ~ 4.5	N • m
—	Weight	Typical value	400	g

ELECTRICAL CHARACTERISTICS (T_j = 25°C)

Symbol	Parameter	Test conditions	Limits			Unit
			Min.	Typ.	Max.	
I _{CES}	Collector cutoff current	V _{CE} = V _{CES} , V _{GE} = 0V	—	—	1	mA
V _{GE(th)}	Gate-emitter threshold voltage	I _C = 20mA, V _{CE} = 10V	5	6	7	V
I _{GES}	Gate leakage current	V _{GE} = V _{CES} , V _{CE} = 0V	—	—	40	μA
V _{CE(sat)}	Collector-emitter saturation voltage	T _j = 25°C	—	1.8	2.4	V
		T _j = 125°C	—	1.9	—	
C _{ies}	Input capacitance	V _{CE} = 10V V _{GE} = 0V	—	—	78	nF
C _{oes}	Output capacitance		—	—	3.4	
C _{res}	Reverse transfer capacitance		—	—	2.0	
Q _G	Total gate charge	V _{CC} = 600V, I _C = 200A, V _{GE} = 15V	—	2200	—	nC
t _{d(on)}	Turn-on delay time	V _{CC} = 600V, I _C = 200A V _{GE1} = V _{GE2} = 15V R _G = 1.6Ω, Inductive load switching operation I _E = 200A	—	—	300	ns
t _r	Turn-on rise time		—	—	80	
t _{d(off)}	Turn-off delay time		—	—	500	
t _f	Turn-off fall time		—	—	300	
t _{rr} (Note 1)	Reverse recovery time		—	—	200	
Q _{rr} (Note 1)	Reverse recovery charge		—	12.2	—	
V _{EC} (Note 1)	Emitter-collector voltage	I _E = 200A, V _{GE} = 0V	—	—	3.2	V
R _{th(j-c)Q}	Thermal resistance *1	IGBT part (1/2 module)	—	—	0.15	°C/W
R _{th(j-c)R}		FWDi part (1/2 module)	—	—	0.18	
R _{th(c-f)}	Contact thermal resistance	Case to fin, Thermal compound applied*2 (1/2 module)	—	0.04	—	
R _{th(j-c)Q}	Thermal resistance	T _c measured point is just under the chips	—	—	0.091*3	
R _G	External gate resistance		1.6	—	16	Ω

Note 1. I_E, V_{EC}, t_{rr}, Q_{rr}, die/dt represent characteristics of the anti-parallel, emitter to collector free-wheel diode. (FWDi).

2. Pulse width and repetition rate should be such that the device junction temp. (T_j) does not exceed T_{jmax} rating.

3. Junction temperature (T_j) should not increase beyond 150°C.

4. Pulse width and repetition rate should be such as to cause negligible temperature rise.

*1 : T_c measured point is indicated in OUTLINE DRAWING.

*2 : Typical value is measured by using Shin-etsu Silicone "G-746".

*3 : If you use this value, R_{th(f-a)} should be measured just under the chips.

PERFORMANCE CURVES

OUTPUT CHARACTERISTICS (TYPICAL)

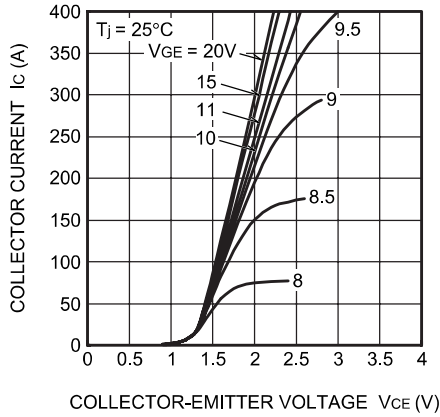

COLLECTOR-EMITTER SATURATION VOLTAGE CHARACTERISTICS (TYPICAL)

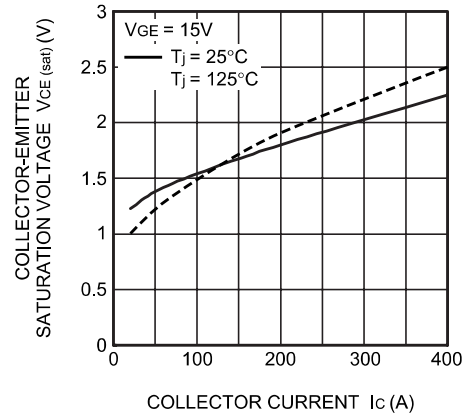

COLLECTOR-EMITTER SATURATION VOLTAGE CHARACTERISTICS (TYPICAL)

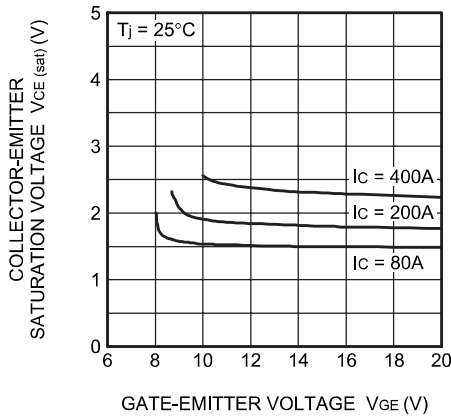

FREE-WHEEL DIODE FORWARD CHARACTERISTICS (TYPICAL)

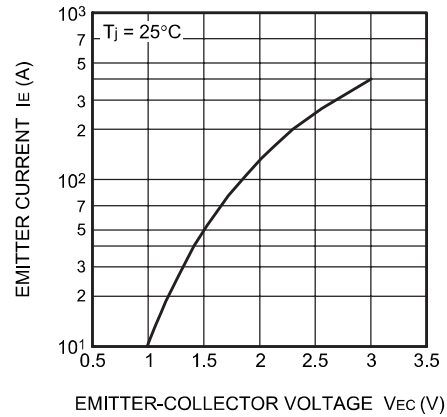

CAPACITANCE- V_{ce} CHARACTERISTICS (TYPICAL)

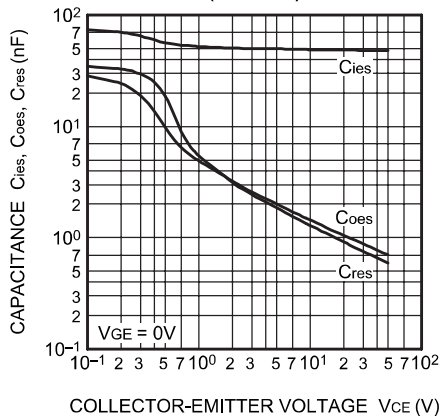

HALF-BRIDGE SWITCHING CHARACTERISTICS (TYPICAL)

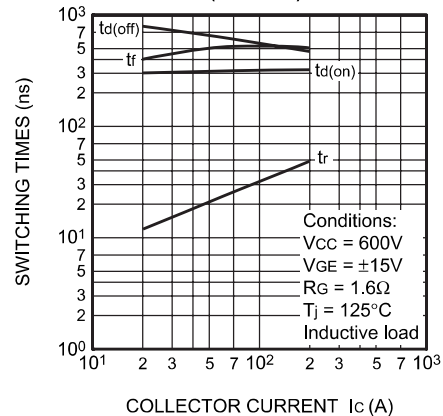

REVERSE RECOVERY CHARACTERISTICS
OF FREE-WHEEL DIODE
(TYPICAL)

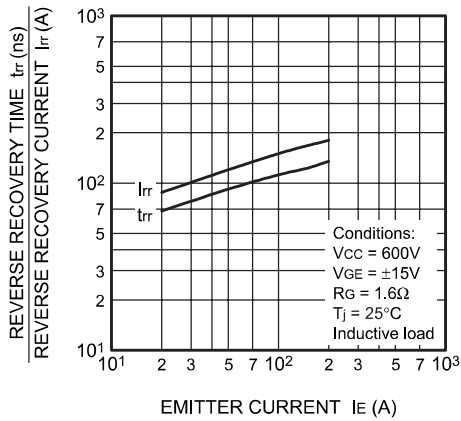

TRANSIENT THERMAL
IMPEDANCE CHARACTERISTICS
(IGBT part & FWDi part)

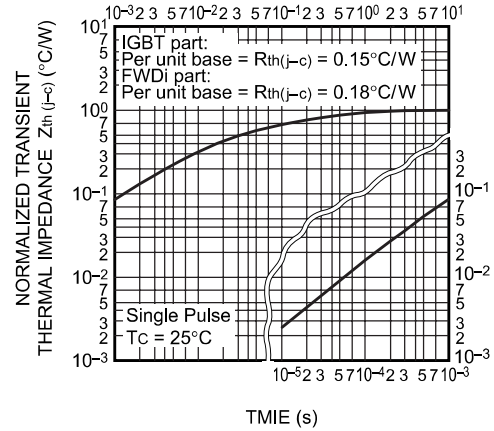

GATE CHARGE
CHARACTERISTICS
(TYPICAL)

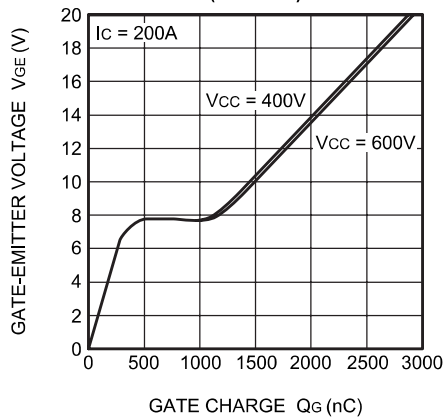

This datasheet has been download from:

www.datasheetcatalog.com

Datasheets for electronics components.