

MITSUBISHI IGBT MODULES
CM400HA-34H
 HIGH POWER SWITCHING USE
 INSULATED TYPE

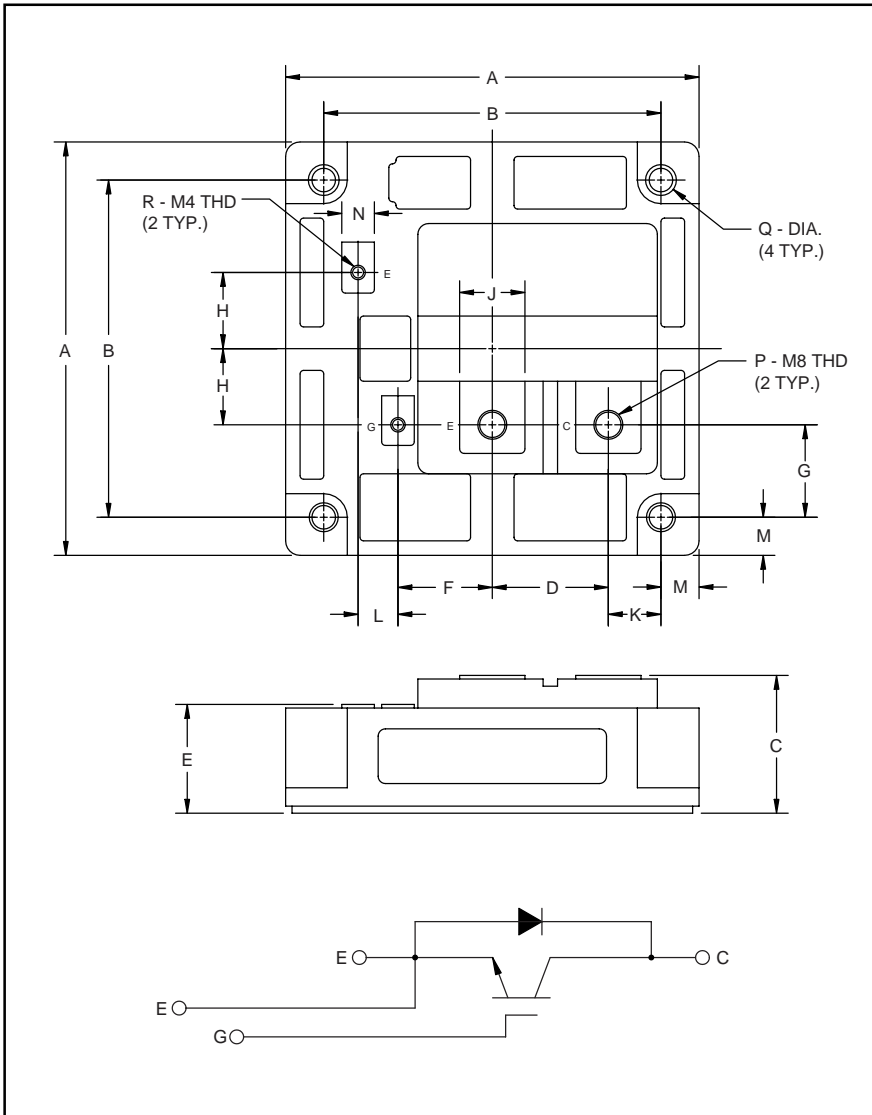

Outline Drawing and Circuit Diagram



Description:

Mitsubishi IGBT Modules are designed for use in switching applications. Each module consists of one IGBT in a single configuration with a reverse-connected super-fast recovery free-wheel diode. All components and interconnects are isolated from the heat sinking baseplate, offering simplified system assembly and thermal management.

Features:

- Low Drive Power
- Low $V_{CE(sat)}$
- Discrete Super-Fast Recovery Free-Wheel Diode
- High Frequency Operation
- Isolated Baseplate for Easy Heat Sinking

Applications:

- AC Motor Control
- Auxilliary Inverter for Traction
- UPS
- Welding Power Supplies

Ordering Information:

Example: Select the complete part module number you desire from the table below -i.e. CM400HA-34H is a 1700V (V_{CES}), 400 Ampere Single IGBT Module.

Dimensions	Inches	Millimeters
A	4.49	114.0
B	3.66±0.01	93.0±0.25
C	1.50+0.04/-0.02	38.0+1.0/-0.5
D	1.26	32.0
E	1.18+0.04/-0.02	30.0+1.0/-0.5
F	1.02	26.0
G	1.0	25.5
H	0.83	21.0

Dimensions	Inches	Millimeters
J	0.71	18.0
K	0.57	14.5
L	0.43	11.0
M	0.41	10.5
N	0.35	9.0
P	M8 Metric	M8
Q	0.26 Dia.	Dia. 6.5
R	M4 Metric	M4

Type	Current Rating Amperes	V_{CES} Volts (x 50)
CM	400	34

CM400HA-34H

HIGH POWER SWITCHING USE
INSULATED TYPE

Absolute Maximum Ratings, $T_j = 25\text{ }^\circ\text{C}$ unless otherwise specified

Ratings	Symbol	CM600HU-12H	Units
Junction Temperature	T_j	-40 to 150	$^\circ\text{C}$
Storage Temperature	T_{stg}	-40 to 125	$^\circ\text{C}$
Collector-Emitter Voltage (G-E SHORT)	V_{CES}	1700	Volts
Gate-Emitter Voltage (C-E SHORT)	V_{GES}	± 20	Volts
Collector Current ($T_c = 25^\circ\text{C}$)	I_C	400	Amperes
Peak Collector Current ($T_j \leq 150^\circ\text{C}$)	I_{CM}	800*	Amperes
Emitter Current** ($T_c = 25^\circ\text{C}$)	I_E	400	Amperes
Peak Emitter Current**	I_{EM}	800*	Amperes
Maximum Collector Dissipation ($T_c = 25^\circ\text{C}$)	P_c	4100	Watts
Mounting Torque, M8 Main Terminal	–	8.83~10.8	N · m
Mounting Torque, M6 Mounting	–	1.96~2.94	N · m
Mounting Torque, M4 Terminal	–	0.98~1.47	N · m
Weight	–	980	Grams
Isolation Voltage (Main Terminal to Baseplate, AC 1 min.)	V_{iso}	4000	Vrms

* Pulse width and repetition rate should be such that the device junction temperature (T_j) does not exceed $T_{j(max)}$ rating.

**Represents characteristics of the anti-parallel, emitter-to-collector free-wheel diode (FWDi).

Static Electrical Characteristics, $T_j = 25\text{ }^\circ\text{C}$ unless otherwise specified

Characteristics	Symbol	Test Conditions	Min.	Typ.	Max.	Units
Collector-Cutoff Current	I_{CES}	$V_{CE} = V_{CES}, V_{GE} = 0V$	–	–	4	mA
Gate Leakage Current	I_{GES}	$V_{GE} = V_{GES}, V_{CE} = 0V$	–	–	0.5	μA
Gate-Emitter Threshold Voltage	$V_{GE(th)}$	$I_C = 40\text{mA}, V_{CE} = 10V$	4.5	6.0	7.5	Volts
Collector-Emitter Saturation Voltage	$V_{CE(sat)}$	$I_C = 400A, V_{GE} = 15V$	–	2.7	3.7**	Volts
		$I_C = 400A, V_{GE} = 15V, T_j = 150^\circ\text{C}$	–	–	–*	Volts
Total Gate Charge	Q_G	$V_{CC} = 750V, I_C = 400A, V_{GE} = 15V$	–	2900	–	nC
Emitter-Collector Voltage	V_{EC}	$I_E = 400A, V_{GE} = 0V$	–	–	3.4	Volts

** Pulse width and repetition rate should be such that device junction temperature rise is negligible.

Dynamic Electrical Characteristics, $T_j = 25\text{ }^\circ\text{C}$ unless otherwise specified

Characteristics	Symbol	Test Conditions	Min.	Typ.	Max.	Units
Input Capacitance	C_{ies}		–	–	85	nF
Output Capacitance	C_{oes}	$V_{GE} = 0V, V_{CE} = 10V$	–	–	20	nF
Reverse Transfer Capacitance	C_{res}		–	–	15	nF
Resistive	Turn-on Delay Time	$t_{d(on)}$	–	–	900	ns
	Rise Time	t_r	–	–	1500	ns
Switching	Turn-off Delay Time	$t_{d(off)}$	–	–	1500	ns
	Fall Time	t_f	–	–	800	ns
Diode Reverse Recovery Time	t_{rr}	$I_E = 400A, di_E/dt = -800A/\mu\text{s}$	–	–	400	ns
Diode Reverse Recovery Charge	Q_{rr}	$I_E = 400A, di_E/dt = -800A/\mu\text{s}$	–	7.0	–	μC

Thermal and Mechanical Characteristics, $T_j = 25\text{ }^\circ\text{C}$ unless otherwise specified

Characteristics	Symbol	Test Conditions	Min.	Typ.	Max.	Units
Thermal Resistance, Junction to Case	$R_{th(j-c)}$	Per IGBT	–	–	0.030	$^\circ\text{C/W}$
Thermal Resistance, Junction to Case	$R_{th(j-c)}$	Per FWDi	–	–	0.060	$^\circ\text{C/W}$
Contact Thermal Resistance	$R_{th(c-f)}$	Per Module, Thermal Grease Applied	–	–	0.023	$^\circ\text{C/W}$

CM400HA-34H

HIGH POWER SWITCHING USE
INSULATED TYPE

OUTPUT CHARACTERISTICS
(TYPICAL)

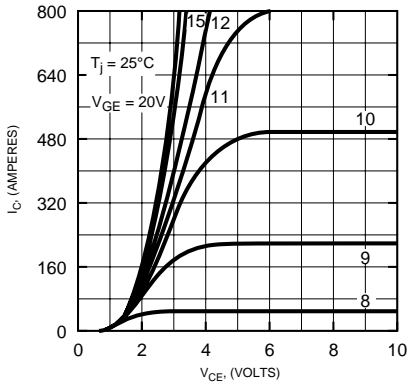

OUTPUT CHARACTERISTICS
(TYPICAL)

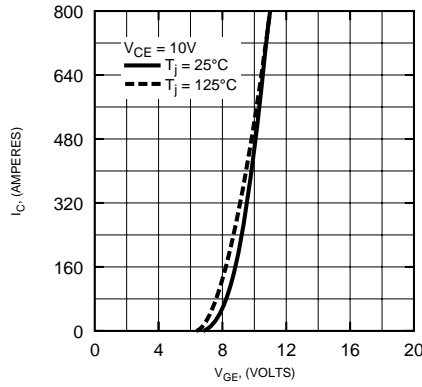

COLLECTOR-EMITTER
SATURATION VOLTAGE CHARACTERISTICS
(TYPICAL)

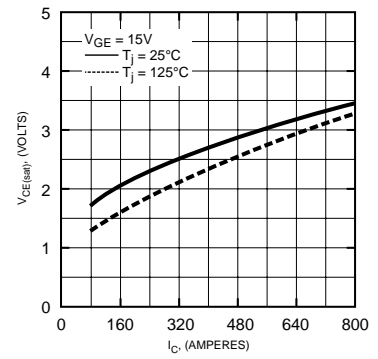

COLLECTOR-EMITTER
SATURATION VOLTAGE CHARACTERISTICS
(TYPICAL)

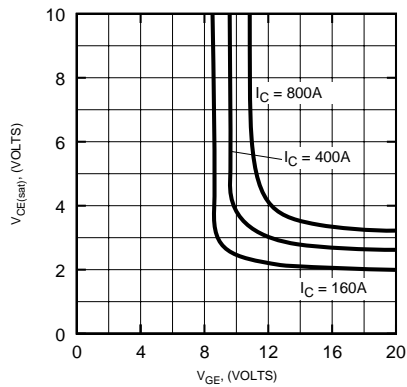

FREE-WHEEL DIODE
FORWARD CHARACTERISTICS
(TYPICAL)

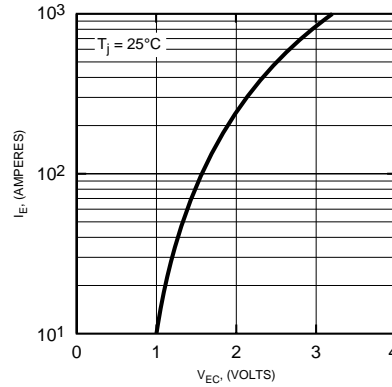

CAPACITANCE VS. V_{CE}
(TYPICAL)

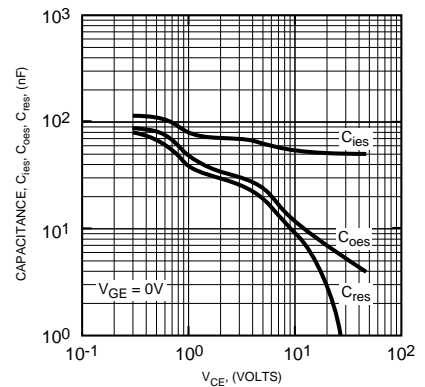

HALF-BRIDGE
SWITCHING CHARACTERISTICS
(TYPICAL)

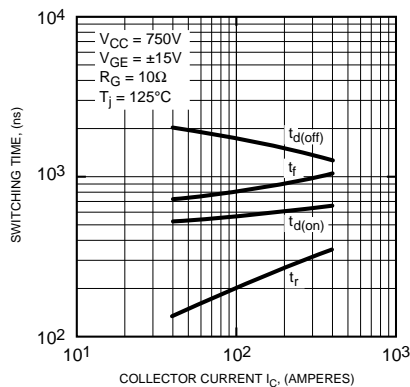

REVERSE RECOVERY CHARACTERISTICS
(TYPICAL)

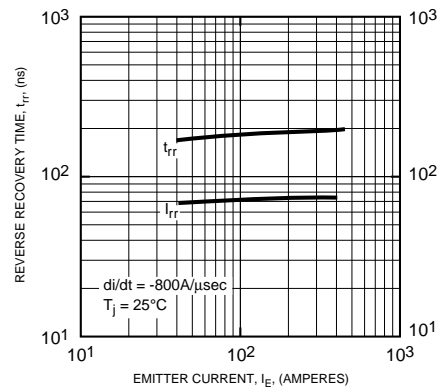

GATE CHARGE, V_{GE}

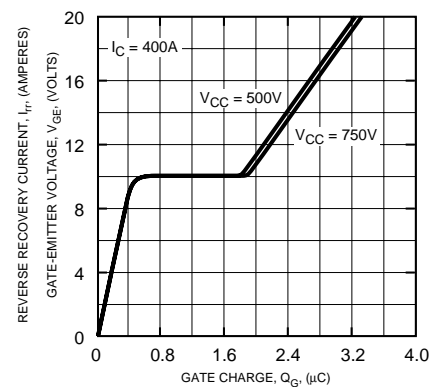

CM400HA-34H

HIGH POWER SWITCHING USE
INSULATED TYPE

