

POWEREX

Powerex, Inc., Hillis Street, Youngwood, Pennsylvania 15697 (412) 925-7272

D67DE

Fast Switching Single Darlington Transistor Module 100 Amperes 500-600-700 Volts

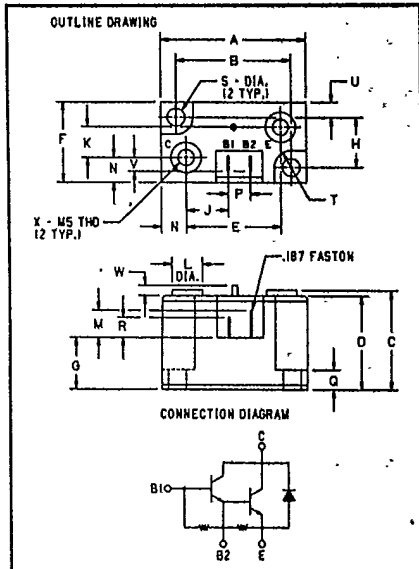

500-600-700 Volt D67DE
Outline Drawing

Dimension	Inches	Millimeters
A	1.800 ± 0.15	45.7 ± 0.4
B	1.420 ± .010	36 ± 0.25
C	1.242 ± .030	31.55 ± 0.8
D	1.173 ± .025	29.8 ± 0.6
E	1.170	29.7
F	1.000 ± .015	25.4 ± 0.4
G	.650 ± .035	16.5 ± 0.9
H	.620 ± .010	15.7 ± 0.25
J	.518	13.2
K	.380 ± .010	9.6 ± 0.25
L	.375 Dia.	9.5 Dia.
M	.335	8.5
N	.310 ± .010	7.9 ± 0.25
P	.275 ± .015	7 ± 0.4
Q	.250 ± .015	6.4 ± 0.4
R	.245	6.2
S	.22 Dia.	5.6 Dia.
T	.21 R	5.3 R
U	.180	4.6
V	.170	4.3
W	.120	3.1
X	M5 Metric	M5

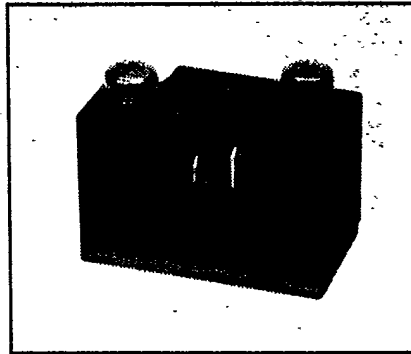

D67DE
Fast Switching Single Darlington
Transistor Module
100 Amperes/500-600-700 Volts

Description

Powerex Fast Switching Single Darlington Transistor Modules are designed for use in switching applications. The modules are isolated consisting of one Darlington Transistor with a monolithic reverse parallel connected free-wheel diode.

Features:

- Isolated Mounting
- High Gain (h_{FE})
- Base 1 and 2 Accessible

Applications:

- UPS Inverters
- DC Motor Control
- Switching Power Supplies
- AC Motor Control

Ordering Information

Example: Select the complete six digit module part number you desire from the table - i.e. D67DE7 is a 700 Volt, 100 Ampere Fast Switching Single Darlington Module.

Type	V _{CEV} Volts (x100)	Current Rating Amperes (100)
D67DE	5	100
D67DE	6	100
D67DE	7	100



Powerex, Inc., Hillis Street, Youngwood, Pennsylvania 15697 (412) 925-7272

D67DE

Fast Switching Single Darlington Transistor Module
100 Amperes/500-600-700 Volts

Maximum Ratings $T_J = 25^\circ\text{C}$ unless otherwise specified

	Symbol	D67DE	Units
Junction Temperature	T_J	-40 to 150	$^\circ\text{C}$
Storage Temperature	T_{STG}	-40 to 150	$^\circ\text{C}$
Collector-Emitter Sustaining Voltage D67DE5	$V_{CE(SUS)}$	400	Volts
Collector-Emitter Voltage $V_{BE} = -1.5\text{V}$ D67DE5	V_{CEV}	500	Volts
Collector-Emitter Sustaining Voltage D67DE6	$V_{CE(SUS)}$	450	Volts
Collector-Emitter Voltage $V_{BE} = -1.5\text{V}$ D67DE6	V_{CEV}	600	Volts
Collector-Emitter Sustaining Voltage D67DE7	$V_{CE(SUS)}$	500	Volts
Collector-Emitter Voltage $V_{BE} = -1.5\text{V}$ D67DE7	V_{CEV}	700	Volts
Emitter-Base Voltage	V_{EBO}	8	Volts
Continuous Collector Current	I_C	100	Amperes
Peak (Repetitive) Collector Current	I_{CM}	150	Amperes
Peak (Non-repetitive) Collector Current	I_{CSM}	250	Amperes
Diode Forward Current	I_{FM}	100	Amperes
Continuous Base Current	I_B	10	Amperes
Peak (Non-repetitive) Base Current	I_{BM}	20	Amperes
Power Dissipation	P_T	312.5	Watts
Max. Mounting Torque (M5) Terminal Screws	—	28	in.-lb.
Max. Mounting Torque (M5) Mounting Screws	—	25	in.-lb.
V isolation	V_{RMS}	2500	Volts

Electrical and Mechanical Characteristics $T_J = 25^\circ\text{C}$ unless otherwise specified

Characteristics	Symbol	Test Conditions	Min.	D67DE Typ.	Max.	Units
Collector Cutoff Current	I_{CEV}	$V_{CE} = V_{CEV}$ (rated), $V_{BE} = -1.5\text{V}$	—	—	1	mA
Collector Cutoff Current	I_{CEV}	$V_{CE} = V_{CEV}$ (rated), $V_{BE} = -1.5\text{V}$ $T_J = 150^\circ\text{C}$	—	—	2.5	mA
Emitter Cutoff Current	I_{EBO}	$V_{EB} = 3.5\text{V}$	—	—	500	mA
DC Current Gain	h_{FE}	$I_C = 150\text{A}$, $V_{CE} = 5.0\text{V}$ $I_C = 100\text{A}$, $V_{CE} = 5.0\text{V}$ $I_C = 40\text{A}$, $V_{CE} = 5.0\text{V}$	25 50 100	90 200 275	— — —	— — —
Collector-Emitter Saturation Voltage	$V_{CE(SAT)}$	$I_C = 150\text{A}$, $I_B = 10.0\text{A}$ $I_C = 100\text{A}$, $I_B = 8.0\text{A}$ $I_C = 40\text{A}$, $I_B = 4.0\text{A}$	— — —	1.9 1.4 1.0	3.0 2.0 1.5	V V V
Base-Emitter Saturation Voltage	$V_{BE(SAT)}$	$I_C = 150\text{A}$, $I_B = 10.0\text{A}$ $I_C = 100\text{A}$, $I_B = 8.0\text{A}$	— —	2.75 2.3	3.5 3.0	V V
Delay Time*	t_d	$V_{CC} = 250\text{V}$	—	0.1	0.5	μs
Rise Time*	t_{on}	$I_C = 100\text{A}$	—	0.45	1.0	μs
Storage Time*	t_s	$I_{B1} = 5\text{A}$, $-I_{B2} = 10.0\text{A}$	—	3.2	5.0	μs
Fall Time*	t_f	$t_p = 50 \mu\text{sec}$	—	1.1	3.0	μs
Diode Forward Voltage	V_{FM}	$I_{FM} = 100\text{A}$ $I_{FM} = 100\text{A}$, $T_J = 150^\circ\text{C}$	— —	1.9 1.75	3.25 3.00	V V
Reverse Recovery Time	t_{rr}	$I_{FM} = 100\text{A}$, $di/dt = 25\text{A}/\mu\text{sec}$ $R_{BIE} = .25\Omega$	—	4.5	10.0	μs
Forward Turn-On Time	t_{ON}	$I_{FM} = 100\text{A}$, $di/dt = 100\text{A}/\mu\text{sec}$	—	1.7	2.5	μs
Thermal Resistance, Junction to Case	$R_{\theta JC}$	Transistor Part	—	—	.4	$^\circ\text{C}/\text{W}$
Thermal Resistance, Junction to Case	$R_{\theta JC}$	Diode Part	—	—	.4	$^\circ\text{C}/\text{W}$

*Resistive Load



Powerex, Inc., Hills Street, Youngwood, Pennsylvania 15697 (412) 925-7272

D67DE
Fast Switching Single Darlington Transistor Module
100 Amperes/500-600-700 Volts

DC CURRENT GAIN (TYPICAL)

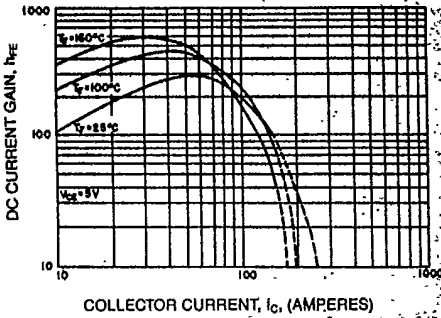

DC CURRENT GAIN (TYPICAL)

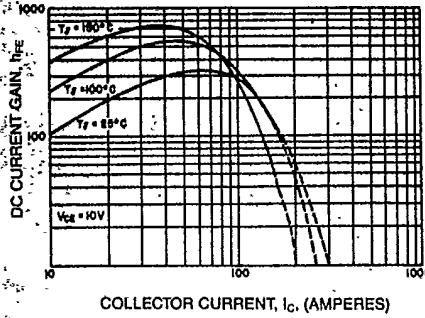

SATURATION VOLTAGE (TYPICAL)

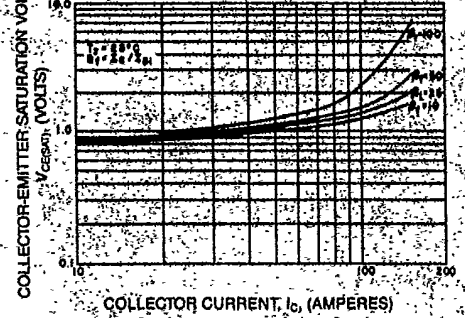

SATURATION VOLTAGE (TYPICAL)

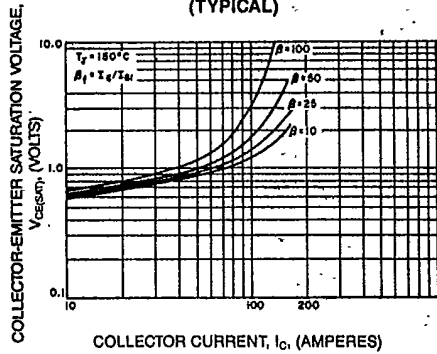

SATURATION VOLTAGE (TYPICAL)

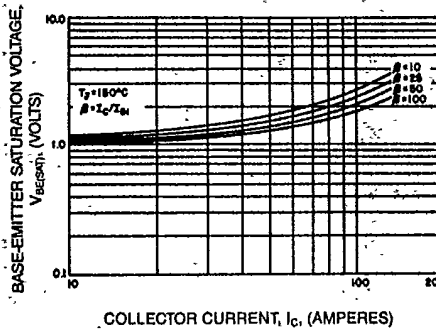

SATURATION VOLTAGE (TYPICAL)

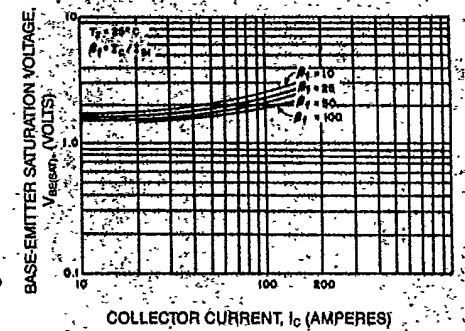

SWITCHING CHARACTERISTICS (TYPICAL)

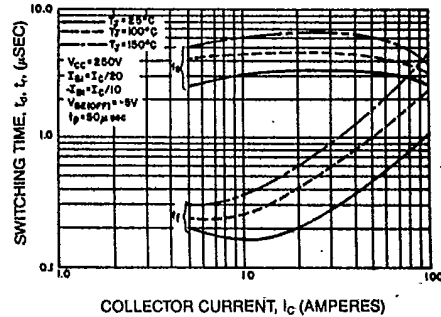

COLLECTOR-EMITTER SATURATION VOLTAGE (TYPICAL)

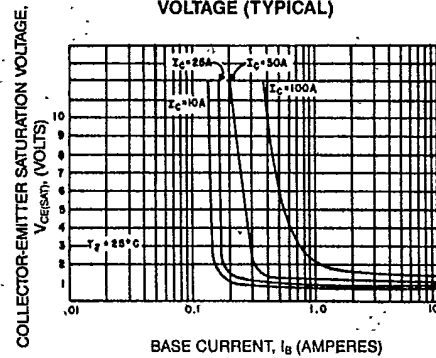

SWITCHING TIME VS. BASE CURRENT (TYPICAL)

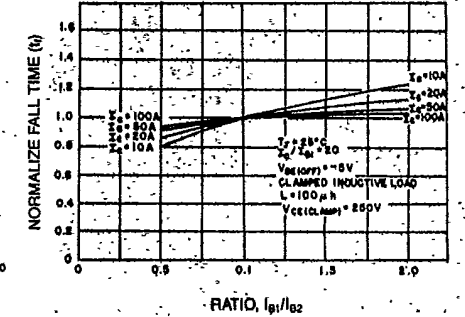



Powerex, Inc., Hillis Street, Youngwood, Pennsylvania 15697 (412) 925-7272

D67DE
Fast Switching Single Darlington Transistor Module
100 Amperes/500-600-700 Volts

SWITCHING TIME VS. BASE CURRENT (TYPICAL)

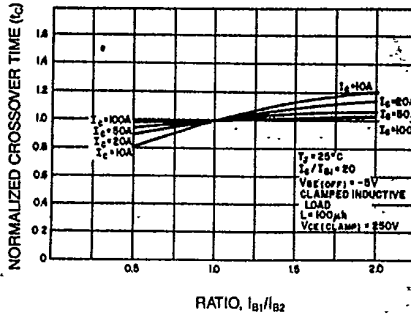

DIODE CHARACTERISTICS (TYPICAL)

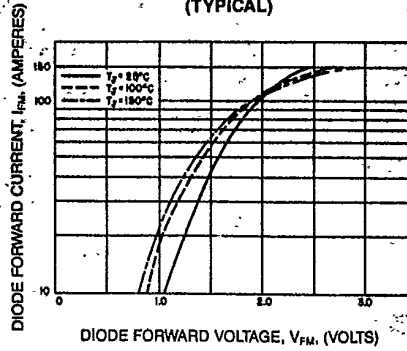

REVERSE BIAS SAFE OPERATING AREA (R.B.S.O.A.)

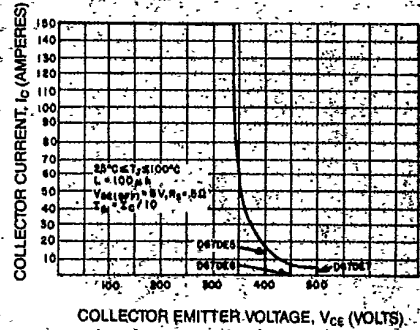

FORWARD BIAS SAFE OPERATING AREA (S.O.A.)

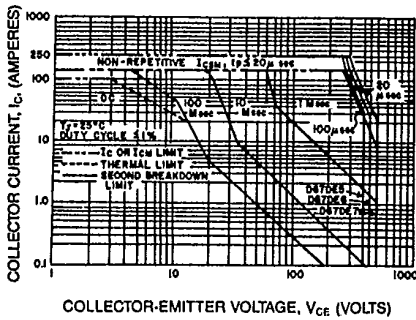

DERATING FACTOR OF SAFE OPERATING AREA (S.O.A.)

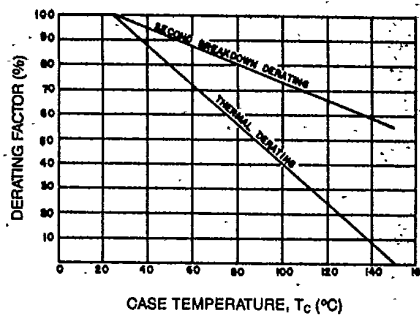

TRANSIENT THERMAL IMPEDANCE CHARACTERISTICS (TRANSISTOR)

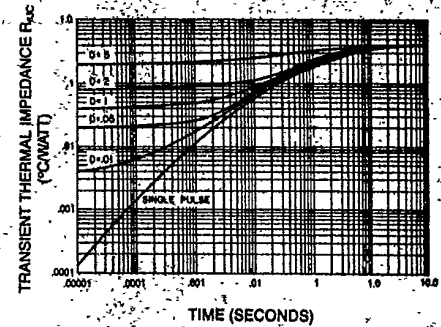

Switching Time Test Circuit

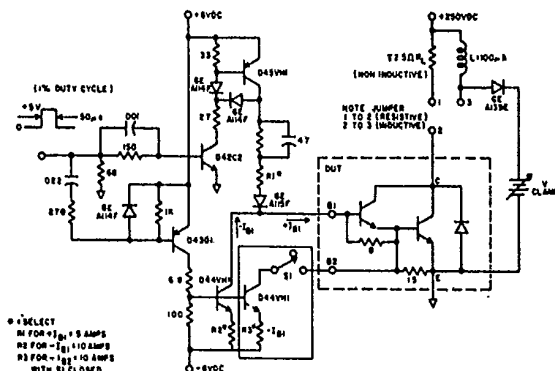

NOTE: UTILIZING SECOND BASE CONNECTION DURING TURN OFF (R1 CLOSED), TYPICAL REDUCTIONS IN TURN-OFF TIMES (t_{f2} , t_{r2} , t_{s2}) RANGE FROM 2:1 TO 10:1. REDUCTION IS PROPORTIONAL TO $\frac{1}{I_{B2}}$.