

MITSUBISHI IGBT MODULES
MG400V1US51A

HIGH POWER SWITCHING APPLICATIONS
 MOTOR CONTROL APPLICATIONS

MG400V1US51A



FEATURE

- The electrodes are isolated from case.
- Enhancement-mode
- Integrates fault-signal output circuit in package. (Short-Circuit and Over-Current)
- UL Recognized Yellow Card No.E80276
File No.E80271

APPLICATION

General purpose inverters, servo drives and motor controls

OUTLINE DRAWING & EQUIVALENT CIRCUIT

Dimensions in mm

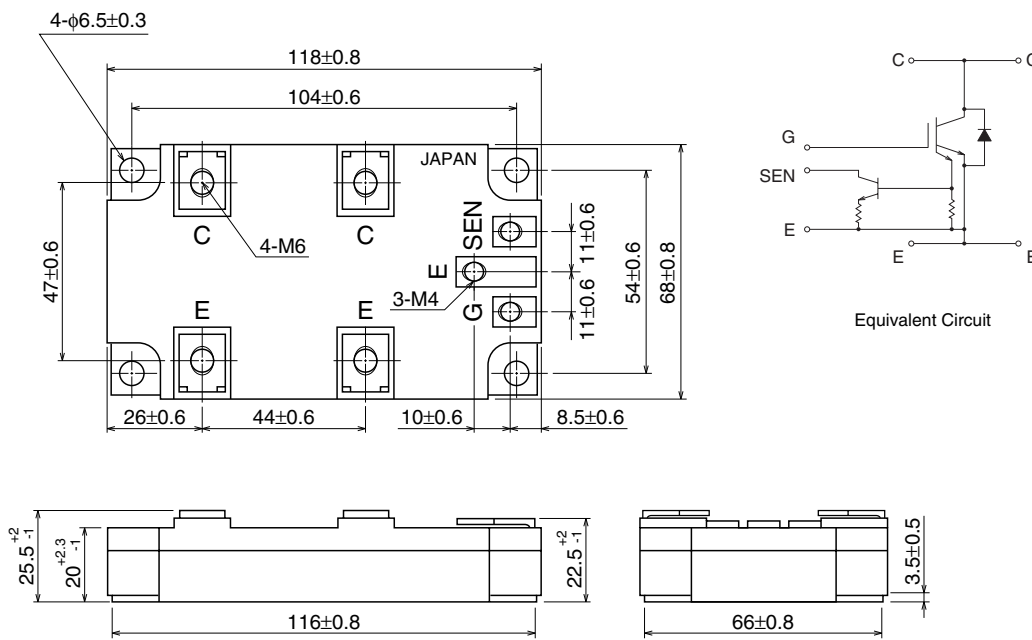

Weight: 420g

MG400V1US51A

**HIGH POWER SWITCHING APPLICATIONS
MOTOR CONTROL APPLICATIONS**

MAXIMUM RATINGS (Ta = 25°C)

Symbol	Parameter		Conditions	Ratings	Unit
V _{CE} S	Collector-emitter voltage			1700	V
V _{GE} S	Gate-emitter voltage			±20	V
V _{SE} S	Sense-emitter voltage			40	V
I _C	Collector	DC		400	A
I _{CP}	current	1ms		800	
I _F	Forward	DC		400	A
I _{FM}	current	1ms		800	
P _C	Collector power dissipation		T _C = 25°C	2750	W
T _j	Junction temperature			150	°C
T _{stg}	Storage temperature range			-40 ~ 125	°C
V _{isol}	Isolation voltage			4000 (AC 1 minute)	V
—	Screw	Terminal (M4/M6)		2/3	N · m
—	torque	Mounting		3	

ELECTRICAL CHARACTERISTICS (Ta = 25°C)

Symbol	Parameter	Test conditions	Limits			Unit	
			Min.	Typ.	Max.		
I _{GES}	Gate leakage current	V _{GE} = ±20V, V _{CE} = 0	—	—	±500	nA	
I _{CES}	Collector cut-off current	V _{CE} = 1700V, V _{GE} = 0	—	—	4.0	mA	
V _{GE(off)}	Gate-emitter cut-off voltage	I _C = 400mA, V _{CE} = 5V	4.0	—	8.0	V	
V _{CE(sat)}	Collector-emitter saturation voltage	I _C = 400A, T _j = 25°C	—	3.2	4.5	V	
C _{ies}	Input capacitance	V _{CE} = 10V, V _{GE} = 0, f = 1MHz	—	51200	—	pF	
t _{d(on)}	Switching time	Turn-on delay time	—	0.14	—	μs	
t _r		Rise time	—	0.07	—		
t _{on}		Turn-on time	Inductive load V _{CC} = 900V	—	0.21		—
t _{d(off)}		Turn-off delay time	I _C = 400A	—	0.49		—
t _f		Fall time	V _{GE} = ±15V	—	0.28		1.0
t _{off}		Turn-off time	R _G = 2Ω (Note 1)	—	0.77		—
V _F	Forward voltage	I _F = 400A, V _{GE} = 0	—	4.0	5.5	V	
t _{rr}	Reverse recovery time	I _F = 400A, V _{GE} = -15V, di/dt = 1500A/μs (Note 1)	—	0.3	0.6	μs	
I _{SES}	Sense	Sense leakage current	V _{SEN} - E = 40V, V _{CE} = 0, V _{GE} = 0	—	—	200	nA
I _{C(SEN-START)}		Sense start current	V _{GE} = 15V, V _{SE} = 14.8V (Note 2)	1050	—	—	A
V _{SEN}		Sense voltage	V _{GE} = 15V, I _C = 2400A (Note 2)	—	—	13.2	V
R _{th(j-c)}	Thermal resistance	Transistor stage	—	—	0.045	°C/W	
		Diode stage	—	—	0.125		

MG400V1US51A

HIGH POWER SWITCHING APPLICATIONS
MOTOR CONTROL APPLICATIONS

Note 1: Switching time and reverse recovery time test circuit and timing chart

Switching time test circuit

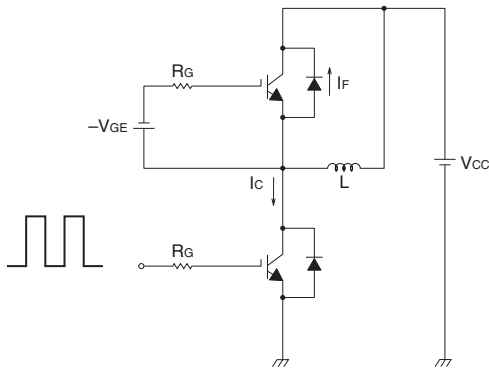

Timing chart

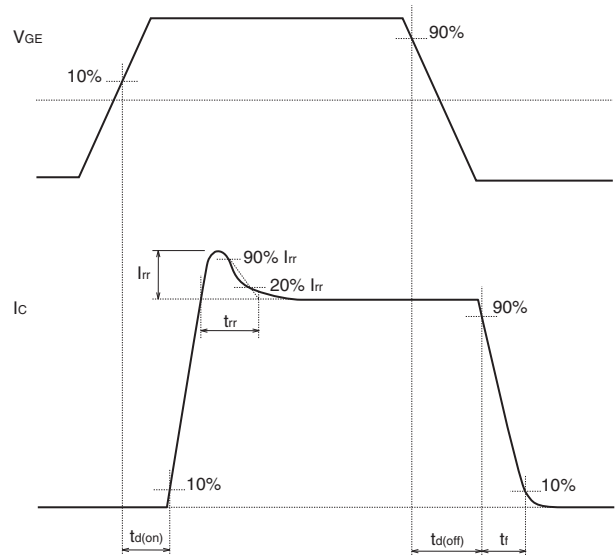

Note 2: Sense start current and sense voltage test circuit

Test circuit

*Measurement in the complete charge period.

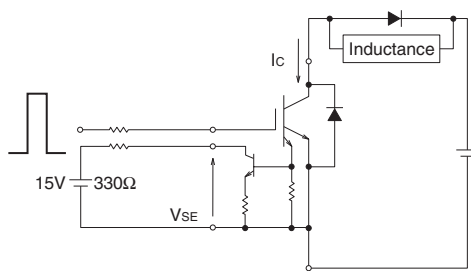

Timing chart

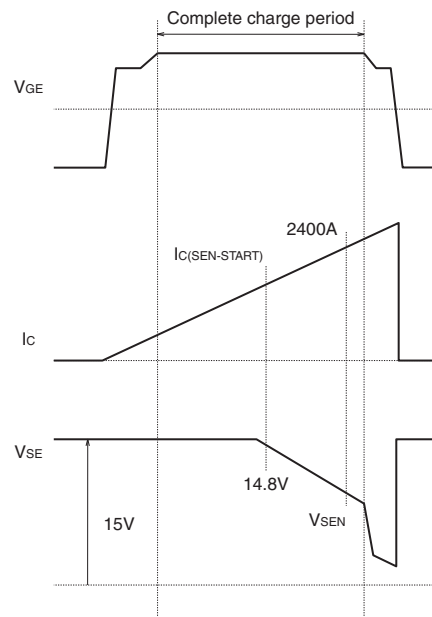

MG400V1US51A

HIGH POWER SWITCHING APPLICATIONS
MOTOR CONTROL APPLICATIONS

<VCE(sat) Rank>

VCE(sat)

Rank symbol	MIN.	MAX.
27	2.4	2.7
28	2.5	2.8
29	2.6	2.9
30	2.7	3.0
31	2.8	3.1
32	2.9	3.2
33	3.0	3.3
34	3.1	3.4
35	3.2	3.5
36	3.3	3.6
37	3.4	3.7
38	3.5	3.8
39	3.6	3.9
40	3.7	4.0
41	3.8	4.1
42	3.9	4.2
43	4.0	4.3
44	4.1	4.4
45	4.2	4.5

<VF Rank>

VF

Rank symbol	MIN.	MAX.
A	4.5	5.5
B	4.0	4.7
C	3.5	4.2
D	3.0	3.7
E	2.5	3.2

<Mark position>

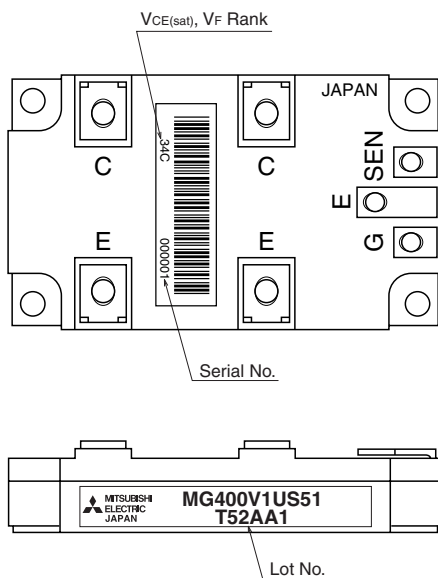

MG400V1US51A

HIGH POWER SWITCHING APPLICATIONS
MOTOR CONTROL APPLICATIONS

PERFORMANCE CURVES

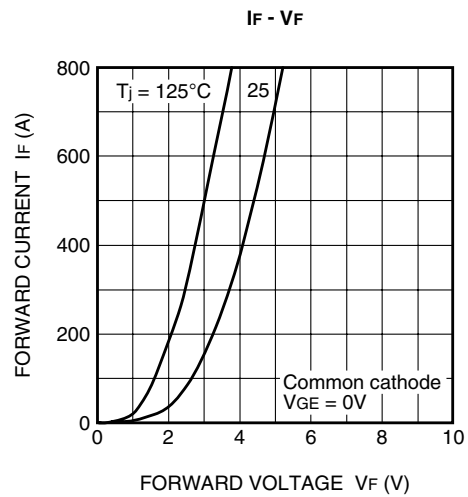
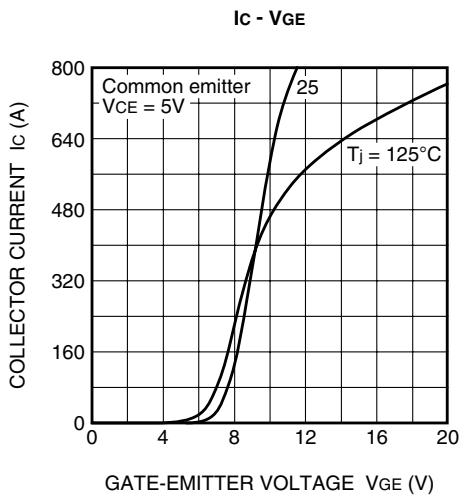
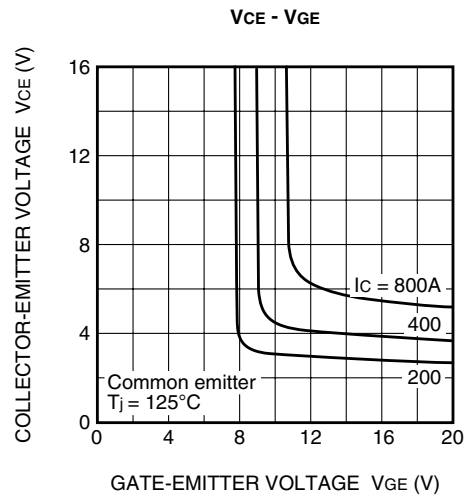
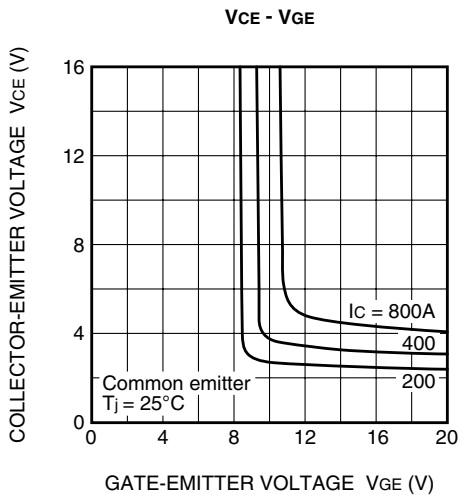
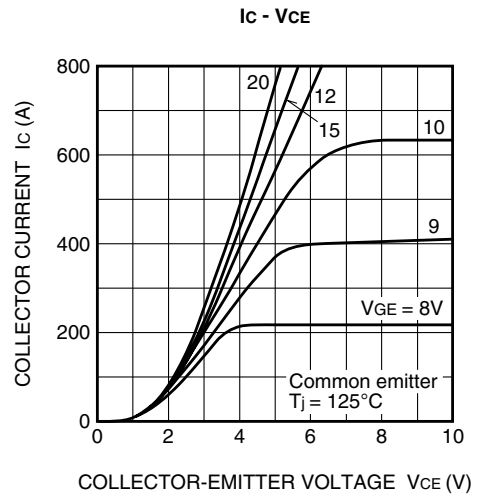
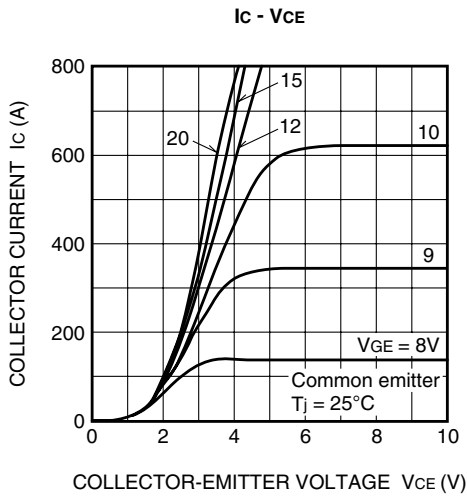

MG400V1US51A

HIGH POWER SWITCHING APPLICATIONS
MOTOR CONTROL APPLICATIONS

SW time - R_G

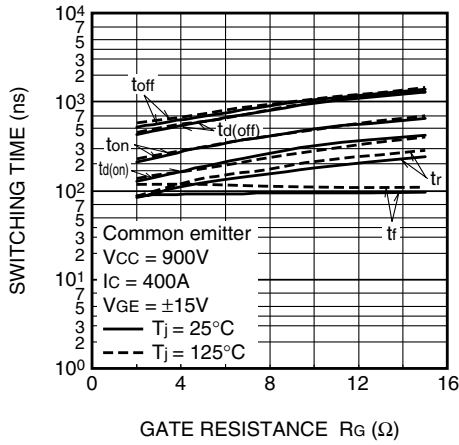

SW time - I_C

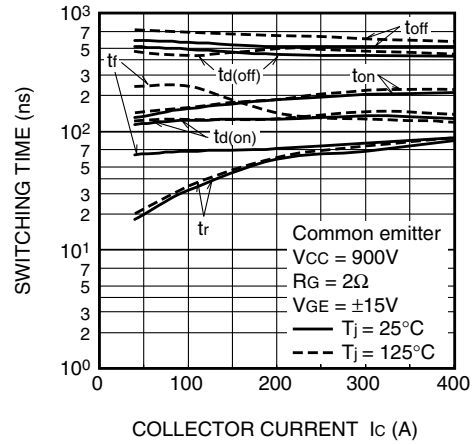

SW loss - R_G

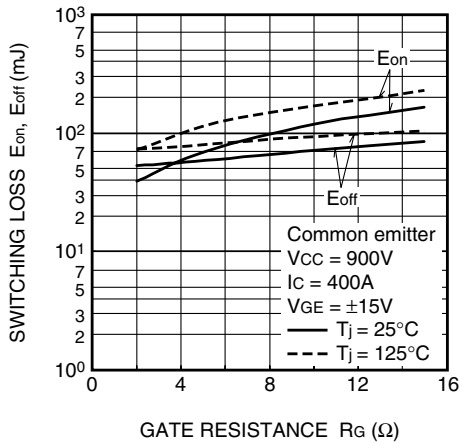

SW loss - I_C

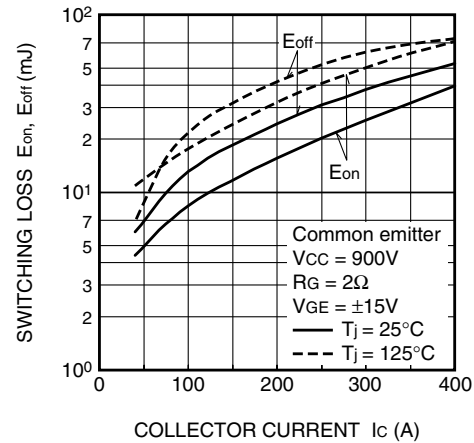

I_{rr}, t_{rr} - R_G

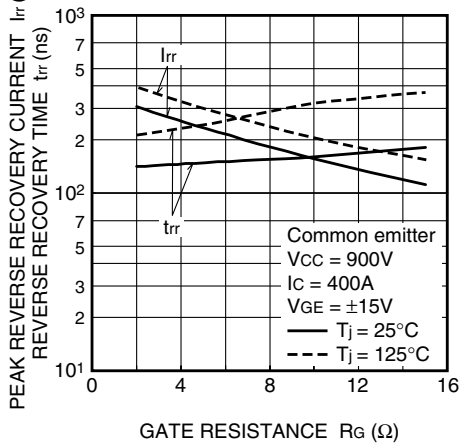

I_{rr}, t_{rr} - I_F

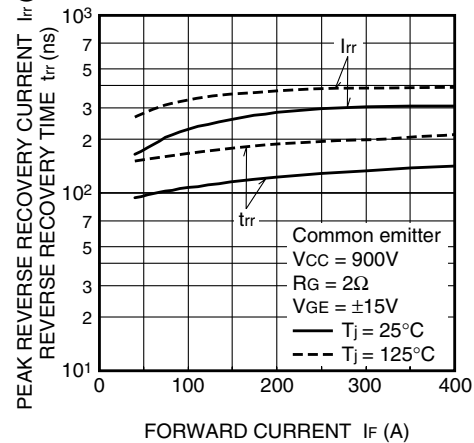

MG400V1US51A

HIGH POWER SWITCHING APPLICATIONS
MOTOR CONTROL APPLICATIONS

