

# MJ14001 (PNP), MJ14002\* (NPN), MJ14003\* (PNP)

\*Preferred Devices

## High-Current Complementary Silicon Power Transistors

Designed for use in high-power amplifier and switching circuit applications.

- High Current Capability –  
 $I_C$  Continuous = 60 Amperes
- DC Current Gain –  
 $h_{FE} = 15-100$  @  $I_C = 50$  Adc
- Low Collector-Emitter Saturation Voltage –  
 $V_{CE(sat)} = 2.5$  Vdc (Max) @  $I_C = 50$  Adc

### MAXIMUM RATINGS

Rating	Symbol	MJ14001	MJ14002 MJ14003	Unit
Collector-Emitter Voltage	$V_{CEO}$	60	80	Vdc
Collector Base Voltage	$V_{CBO}$	60	80	Vdc
Emitter-Base Voltage	$V_{EBO}$	5.0		Vdc
Collector Current – Continuous	$I_C$	60		Adc
Base Current – Continuous	$I_B$	15		Adc
Emitter Current – Continuous	$I_E$	75		
Total Power Dissipation @ $T_C = 25^\circ\text{C}$ Derate above $25^\circ\text{C}$	$P_D$	300		Watts
		1.71		W/°C
Operating and Storage Junction Temperature Range	$T_J, T_{stg}$	-65 to +200		°C

### THERMAL CHARACTERISTICS

Characteristic	Symbol	Max	Unit
Thermal Resistance, Junction to Case	$R_{\theta JC}$	0.584	°C/W

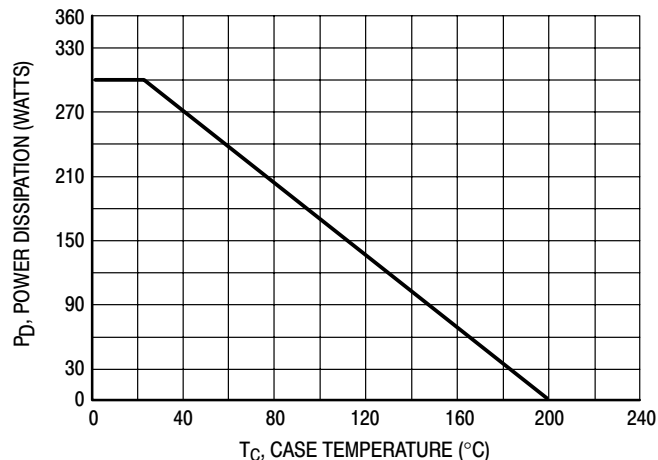

Figure 1. Power Derating



ON Semiconductor®

<http://onsemi.com>

## COMPLEMENTARY SILICON POWER TRANSISTORS 60 AMPERES 60-80 VOLTS 300 WATTS

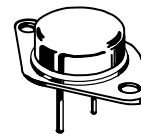

TO-204 (TO-3)  
STYLE 1  
CASE 197A

### MARKING DIAGRAM

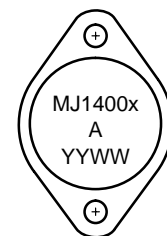

MJ1400x = Device Code  
A = Assembly Location  
YY = Year  
WW = Work Week  
x = 1, 2, or 3

### ORDERING INFORMATION

Device	Package	Shipping
MJ14001	TO-3	100 Units/Tray
MJ14002	TO-3	100 Units/Tray
MJ14003	TO-3	100 Units/Tray

Preferred devices are recommended choices for future use and best overall value.

# MJ14001 (PNP), MJ14002\* (NPN), MJ14003\* (PNP)

## ELECTRICAL CHARACTERISTICS ( $T_C = 25^\circ\text{C}$ unless otherwise noted)

Characteristic	Symbol	Min	Max	Unit
<b>OFF CHARACTERISTICS</b>				
Collector–Emitter Sustaining Voltage (Note 1) ( $I_C = 200\text{ mAdc}$ , $I_B = 0$ )	$V_{CE(sus)}$	60 80	– –	Vdc
Collector Cutoff Current ( $V_{CE} = 30\text{ Vdc}$ , $I_B = 0$ ) ( $V_{CE} = 40\text{ Vdc}$ , $I_B = 0$ )	$I_{CEO}$	– –	1.0 1.0	mA
Collector Cutoff Current ( $V_{CE} = 60\text{ Vdc}$ , $V_{BE(off)} = 1.5\text{ V}$ ) ( $V_{CE} = 80\text{ Vdc}$ , $V_{BE(off)} = 1.5\text{ V}$ )	$I_{CEX}$	– –	1.0 1.0	mA
Collector Cutoff Current ( $V_{CB} = 60\text{ Vdc}$ , $I_E = 0$ ) ( $V_{CB} = 80\text{ Vdc}$ , $I_E = 0$ )	$I_{CBO}$	– –	1.0 1.0	mA
Emitter Cutoff Current ( $V_{BE} = 5.0\text{ Vdc}$ , $I_C = 0$ )	$I_{EBO}$	–	1.0	mA

## ON CHARACTERISTICS

DC Current Gain (Note 1) ( $I_C = 25\text{ Adc}$ , $V_{CE} = 3.0\text{ V}$ ) ( $I_C = 50\text{ Adc}$ , $V_{CE} = 3.0\text{ V}$ ) ( $I_C = 60\text{ Adc}$ , $V_{CE} = 3.0\text{ V}$ )	$h_{FE}$	30 15 5.0	– 100 –	–
Collector–Emitter Saturation Voltage (Note 1) ( $I_C = 25\text{ Adc}$ , $I_B = 2.5\text{ Adc}$ ) ( $I_C = 50\text{ Adc}$ , $I_B = 5.0\text{ Adc}$ ) ( $I_C = 60\text{ Adc}$ , $I_B = 12\text{ Adc}$ )	$V_{CE(sat)}$	– – –	1.0 2.5 3.0	Vdc
Base–Emitter Saturation Voltage (Note 1) ( $I_C = 25\text{ Adc}$ , $I_B = 2.5\text{ Adc}$ ) ( $I_C = 50\text{ Adc}$ , $I_B = 5.0\text{ Adc}$ ) ( $I_C = 60\text{ Adc}$ , $I_B = 12\text{ Adc}$ )	$V_{BE(sat)}$	– – –	2.0 3.0 4.0	Vdc

## DYNAMIC CHARACTERISTICS

Output Capacitance ( $V_{CB} = 10\text{ Vdc}$ , $I_E = 0$ , $f = 0.1\text{ MHz}$ )	$C_{ob}$	–	2000	pF
---	----------	---	------	----

1. Pulse Test: Pulse Width = 300  $\mu\text{s}$ , Duty Cycle  $\leq 2\%$ .

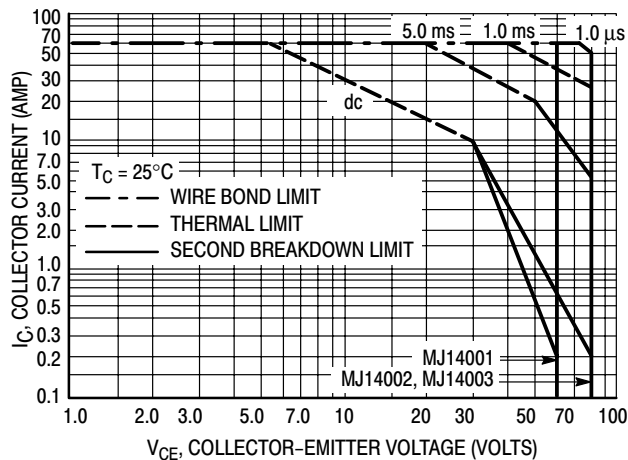

**Figure 2. Maximum Rated Forward Biased Safe Operating Area**

There are two limitations on the power handling ability of a transistor: average junction temperature and second breakdown. Safe operating area curves indicate  $I_C - V_{CE}$  limits of the transistor that must be observed for reliable operation: i.e., the transistor must not be subjected to greater dissipation than the curves indicate.

The data of Figure 2 is based on  $T_{J(pk)} = 200^\circ\text{C}$ ;  $T_C$  is variable depending on conditions. Second breakdown pulse limits are valid for duty cycles to 10% provided  $T_{J(pk)} \leq 200^\circ\text{C}$ .  $T_{J(pk)}$  may be calculated from the data in Figure 13. At high case temperatures, thermal limitations will reduce the power that can be handled to values less than the limitations imposed by second breakdown.

# MJ14001 (PNP), MJ14002\* (NPN), MJ14003\* (PNP)

## TYPICAL ELECTRICAL CHARACTERISTICS

MJ14002 (NPN)

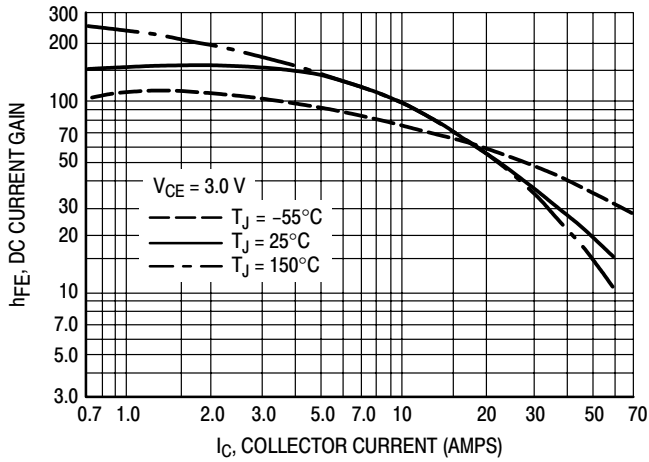

Figure 3. DC Current Gain

MJ14001, MJ14003 (PNP)

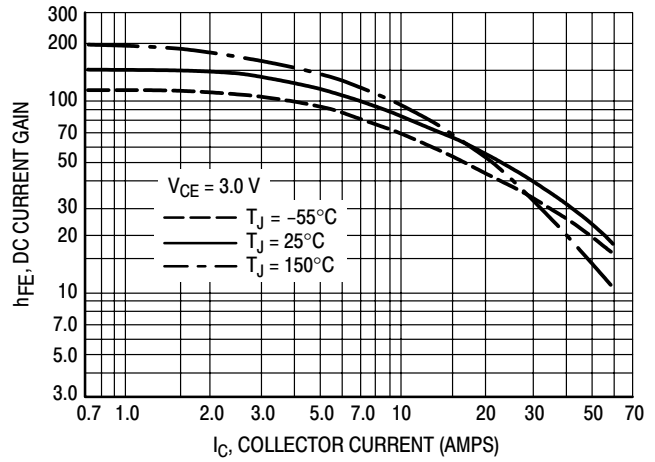

Figure 4. DC Current Gain

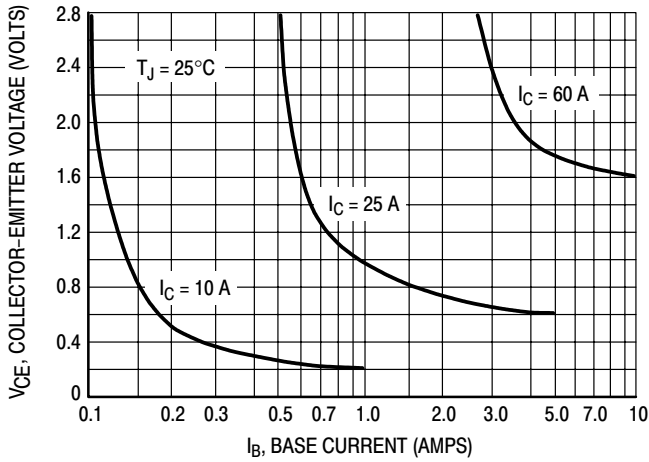

Figure 5. Collector Saturation Region

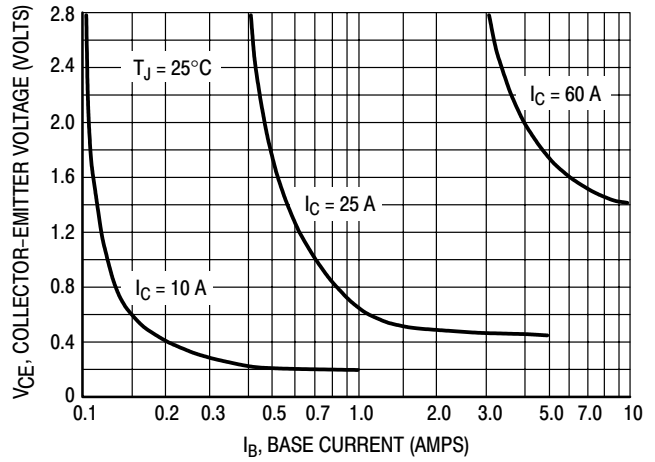

Figure 6. Collector Saturation Region

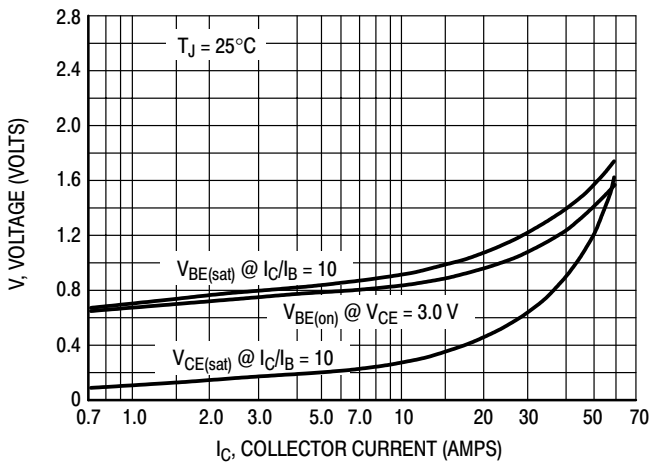

Figure 7. "On" Voltages

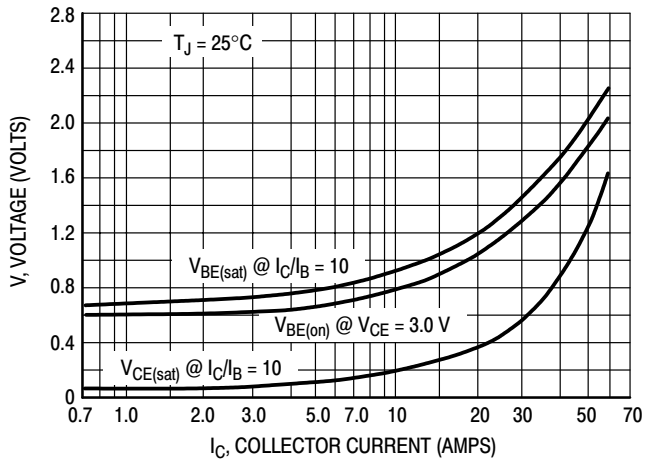

Figure 8. "On" Voltages

# MJ14001 (PNP), MJ14002\* (NPN), MJ14003\* (PNP)

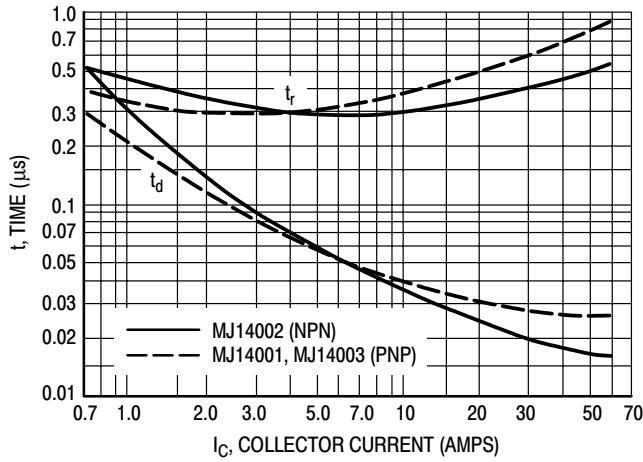

Figure 9. Turn-On Switching Times

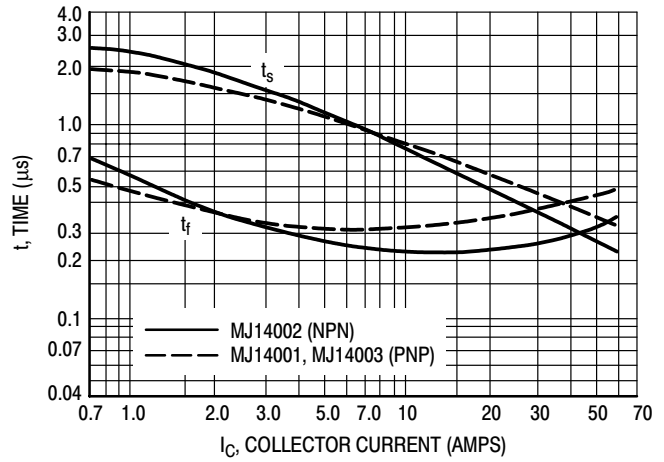

Figure 10. Turn-Off Switching Times

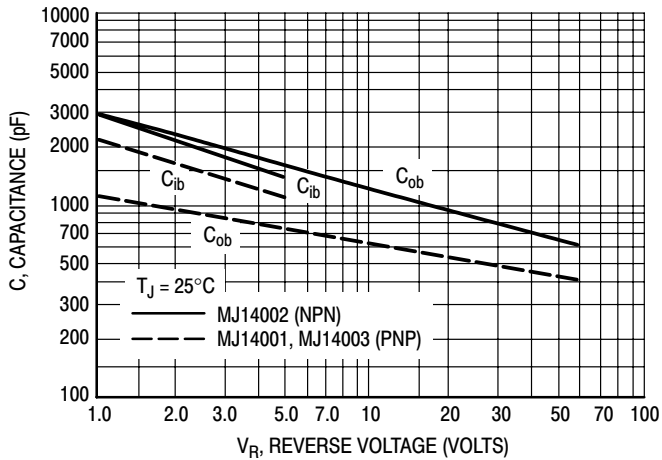
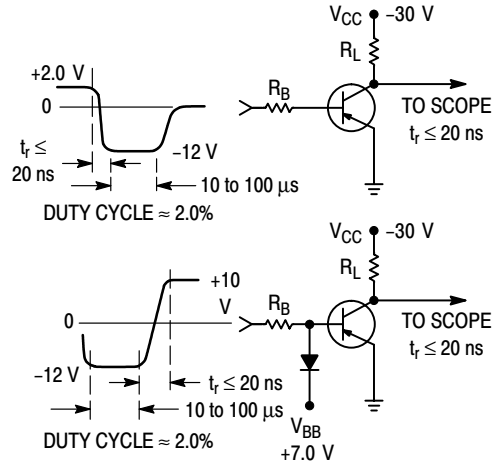

Figure 11. Capacitance Variation



FOR CURVES OF FIGURES 3 & 6,  $R_B$  &  $R_L$  ARE VARIED. INPUT LEVELS ARE APPROXIMATELY AS SHOWN. FOR NPN CIRCUITS, REVERSE ALL POLARITIES.

Figure 12. Switching Test Circuit

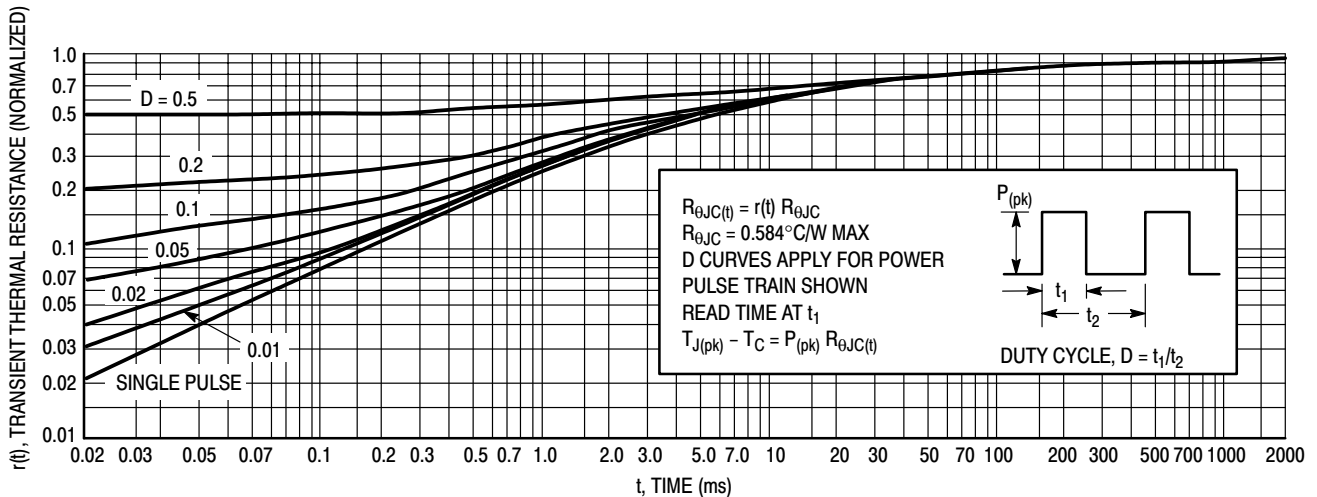
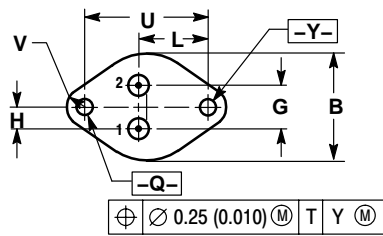
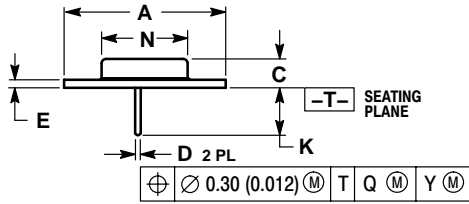

Figure 13. Thermal Response

# MJ14001 (PNP), MJ14002\* (NPN), MJ14003\* (PNP)

## PACKAGE DIMENSIONS

TO-204 (TO-3)  
CASE 197A-05  
ISSUE K



NOTES:

1. DIMENSIONING AND TOLERANCING PER ANSI Y14.5M, 1982.
2. CONTROLLING DIMENSION: INCH.

DIM	INCHES		MILLIMETERS	
	MIN	MAX	MIN	MAX
A	1.530 REF		38.86 REF	
B	0.990	1.050	25.15	26.67
C	0.250	0.335	6.35	8.51
D	0.057	0.063	1.45	1.60
E	0.060	0.070	1.53	1.77
G	0.430 BSC		10.92 BSC	
H	0.215 BSC		5.46 BSC	
K	0.440	0.480	11.18	12.19
L	0.665 BSC		16.89 BSC	
N	0.760	0.830	19.31	21.08
Q	0.151	0.165	3.84	4.19
U	1.187 BSC		30.15 BSC	
V	0.131	0.188	3.33	4.77

STYLE 1:

PIN 1: BASE

2: EMITTER

CASE: COLLECTOR

## MJ14001 (PNP), MJ14002\* (NPN), MJ14003\* (PNP)

**ON Semiconductor** and  are registered trademarks of Semiconductor Components Industries, LLC (SCILLC). SCILLC reserves the right to make changes without further notice to any products herein. SCILLC makes no warranty, representation or guarantee regarding the suitability of its products for any particular purpose, nor does SCILLC assume any liability arising out of the application or use of any product or circuit, and specifically disclaims any and all liability, including without limitation special, consequential or incidental damages. "Typical" parameters which may be provided in SCILLC data sheets and/or specifications can and do vary in different applications and actual performance may vary over time. All operating parameters, including "Typicals" must be validated for each customer application by customer's technical experts. SCILLC does not convey any license under its patent rights nor the rights of others. SCILLC products are not designed, intended, or authorized for use as components in systems intended for surgical implant into the body, or other applications intended to support or sustain life, or for any other application in which the failure of the SCILLC product could create a situation where personal injury or death may occur. Should Buyer purchase or use SCILLC products for any such unintended or unauthorized application, Buyer shall indemnify and hold SCILLC and its officers, employees, subsidiaries, affiliates, and distributors harmless against all claims, costs, damages, and expenses, and reasonable attorney fees arising out of, directly or indirectly, any claim of personal injury or death associated with such unintended or unauthorized use, even if such claim alleges that SCILLC was negligent regarding the design or manufacture of the part. SCILLC is an Equal Opportunity/Affirmative Action Employer.

### PUBLICATION ORDERING INFORMATION

**Literature Fulfillment:**

Literature Distribution Center for ON Semiconductor  
P.O. Box 5163, Denver, Colorado 80217 USA  
**Phone:** 303-675-2175 or 800-344-3860 Toll Free USA/Canada  
**Fax:** 303-675-2176 or 800-344-3867 Toll Free USA/Canada  
**Email:** orderlit@onsemi.com

**N. American Technical Support:** 800-282-9855 Toll Free USA/Canada

**JAPAN:** ON Semiconductor, Japan Customer Focus Center  
2-9-1 Kamimeguro, Meguro-ku, Tokyo, Japan 153-0051  
**Phone:** 81-3-5773-3850

**ON Semiconductor Website:** <http://onsemi.com>

For additional information, please contact your local Sales Representative.

This datasheet has been download from:

[www.datasheetcatalog.com](http://www.datasheetcatalog.com)

Datasheets for electronics components.