

# QM200DY-HB

HIGH POWER SWITCHING USE  
INSULATED TYPE

**QM200DY-HB**



- **I<sub>c</sub>** Collector current ..... **200A**
- **V<sub>CEX</sub>** Collector-emitter voltage ..... **600V**
- **h<sub>FE</sub>** DC current gain ..... **750**
- **Insulated Type**
- **UL Recognized**  
Yellow Card No. E80276 (N)  
File No. E80271

**APPLICATION**

Inverters, Servo drives, DC motor controllers, NC equipment, Welders

**OUTLINE DRAWING & CIRCUIT DIAGRAM**

Dimensions in mm

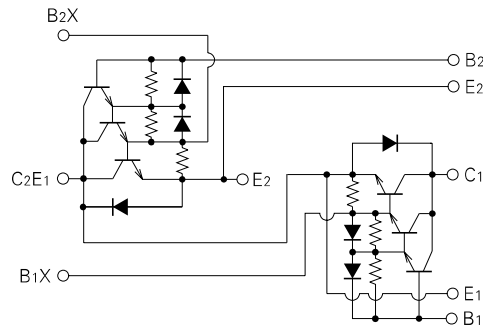
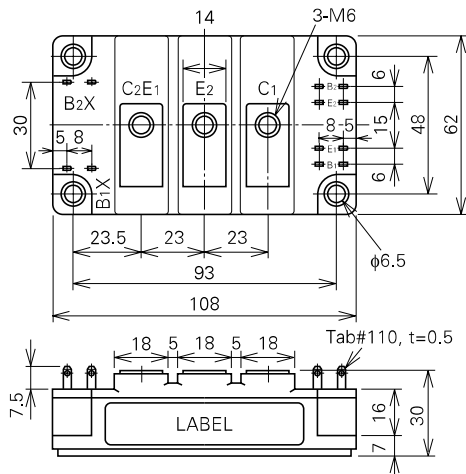

# QM200DY-HB

HIGH POWER SWITCHING USE  
INSULATED TYPE

## ABSOLUTE MAXIMUM RATINGS (T<sub>j</sub>=25°C, unless otherwise noted)

Symbol	Parameter	Conditions	Ratings	Unit
V <sub>CEX (SUS)</sub>	Collector-emitter voltage	I <sub>c</sub> =1A, V <sub>EB</sub> =2V	600	V
V <sub>CEX</sub>	Collector-emitter voltage	V <sub>EB</sub> =2V	600	V
V <sub>CBO</sub>	Collector-base voltage	Emitter open	600	V
V <sub>EBO</sub>	Emitter-base voltage	Collector open	7	V
I <sub>c</sub>	Collector current	DC	200	A
-I <sub>c</sub>	Collector reverse current	DC (forward diode current)	200	A
P <sub>c</sub>	Collector dissipation	T <sub>c</sub> =25°C	1240	W
I <sub>B</sub>	Base current	DC	12	A
-I <sub>cSM</sub>	Surge collector reverse current (forward diode current)	Peak value of one cycle of 60Hz (half wave)	2000	A
T <sub>j</sub>	Junction temperature		-40~+150	°C
T <sub>stg</sub>	Storage temperature		-40~+125	°C
V <sub>iso</sub>	Isolation voltage	Charged part to case, AC for 1 minute	2500	V
—	Mounting torque	Main terminal screw M6	1.96~2.94	N·m
			20~30	kg·cm
		Mounting screw M6	1.96~2.94	N·m
			20~30	kg·cm
—	Weight	Typical value	470	g

## ELECTRICAL CHARACTERISTICS (T<sub>j</sub>=25°C, unless otherwise noted)

Symbol	Parameter	Test conditions	Limits			Unit
			Min.	Typ.	Max.	
I <sub>CEX</sub>	Collector cutoff current	V <sub>CE</sub> =600V, V <sub>EB</sub> =2V	—	—	4.0	mA
I <sub>CBO</sub>	Collector cutoff current	V <sub>CB</sub> =600V, Emitter open	—	—	4.0	mA
I <sub>EBO</sub>	Emitter cutoff current	V <sub>EB</sub> =7V	—	—	200	mA
V <sub>CE (sat)</sub>	Collector-emitter saturation voltage	I <sub>c</sub> =200A, I <sub>B</sub> =260A	—	—	2.5	V
V <sub>BE (sat)</sub>	Base-emitter saturation voltage		—	—	3.0	V
-V <sub>CEO</sub>	Collector-emitter reverse voltage	-I <sub>c</sub> =200A (diode forward voltage)	—	—	1.8	V
h <sub>FE</sub>	DC current gain	I <sub>c</sub> =200A, V <sub>CE</sub> =2.5V	750	—	—	—
t <sub>on</sub>	Switching time	V <sub>CC</sub> =300V, I <sub>c</sub> =200A, I <sub>B1</sub> =400mA, -I <sub>B2</sub> =4A	—	—	2.5	μs
t <sub>s</sub>			—	—	10	μs
t <sub>f</sub>			—	—	2.0	μs
R <sub>th (j-c) Q</sub>	Thermal resistance (junction to case)	Transistor part (per 1/2 module)	—	—	0.1	°C/W
R <sub>th (j-c) R</sub>	Thermal resistance (junction to case)	Diode part (per 1/2 module)	—	—	0.33	°C/W
R <sub>th (c-f)</sub>	Contact thermal resistance (case to fin)	Conductive grease applied (per 1/2 module)	—	—	0.075	°C/W

**QM200DY-HB**

HIGH POWER SWITCHING USE  
INSULATED TYPE

**PERFORMANCE CURVES**

**COMMON EMITTER OUTPUT CHARACTERISTICS (TYPICAL)**

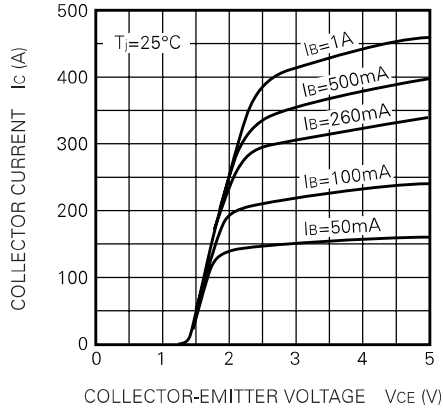

**DC CURRENT GAIN VS. COLLECTOR CURRENT (TYPICAL)**

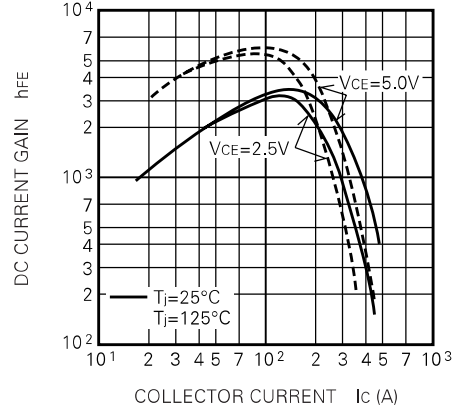

**COMMON EMITTER INPUT CHARACTERISTIC (TYPICAL)**

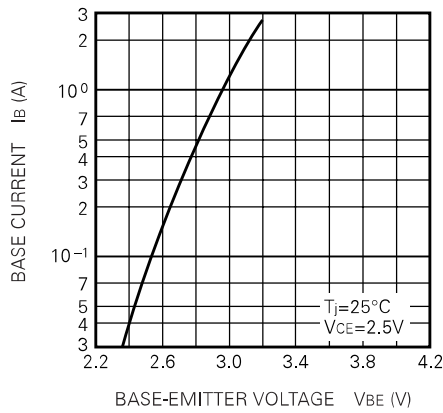

**SATURATION VOLTAGE CHARACTERISTICS (TYPICAL)**

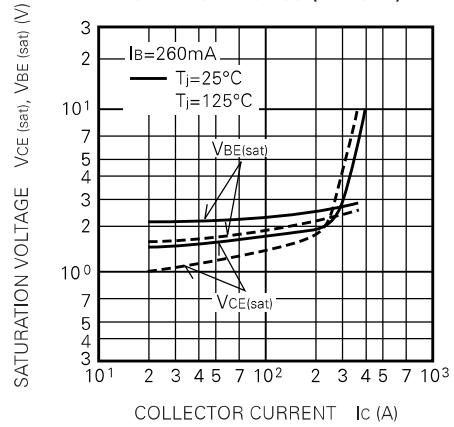

**COLLECTOR-EMITTER SATURATION VOLTAGE (TYPICAL)**

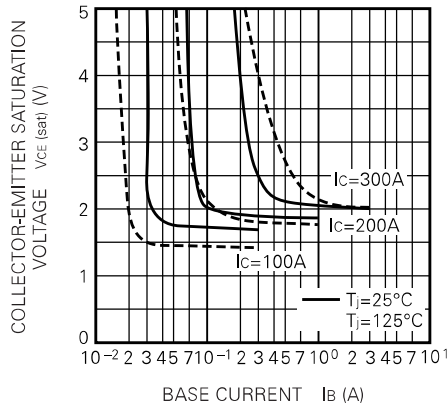

**SWITCHING TIME VS. COLLECTOR CURRENT (TYPICAL)**

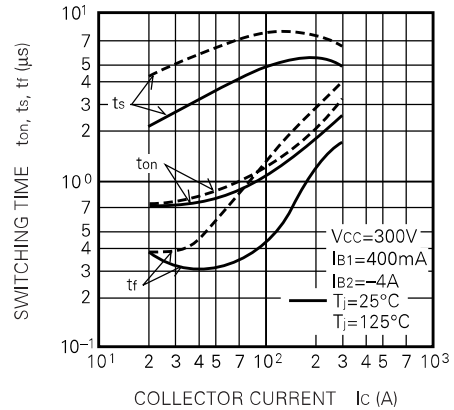

**QM200DY-HB**

**HIGH POWER SWITCHING USE  
INSULATED TYPE**

**SWITCHING TIME VS. BASE CURRENT (TYPICAL)**

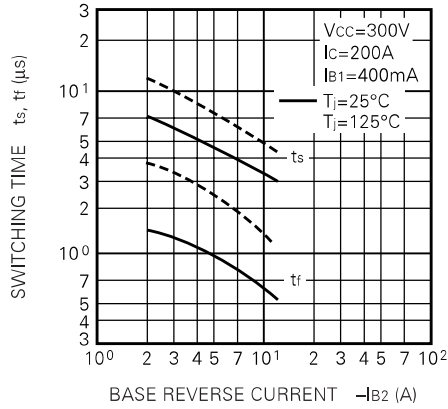

**REVERSE BIAS SAFE OPERATING AREA**

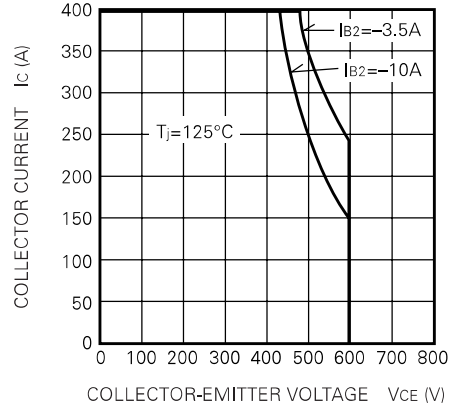

**FORWARD BIAS SAFE OPERATING AREA**

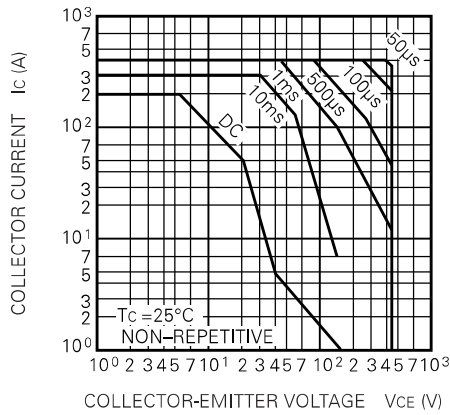

**DERATING FACTOR OF F. B. S. O. A.**

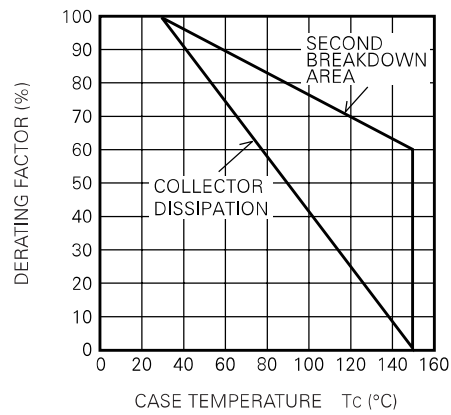

**TRANSIENT THERMAL IMPEDANCE CHARACTERISTIC (TRANSISTOR)**

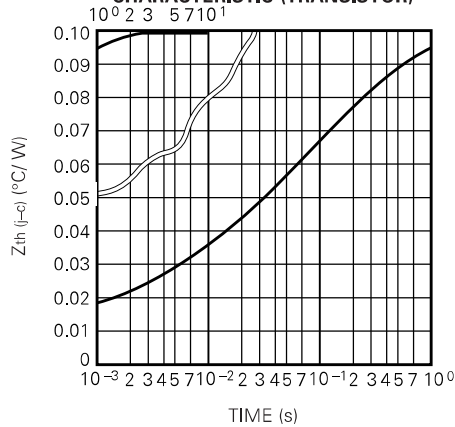

**REVERSE COLLECTOR CURRENT VS. COLLECTOR-EMITTER REVERSE VOLTAGE (DIODE FORWARD CHARACTERISTICS) (TYPICAL)**

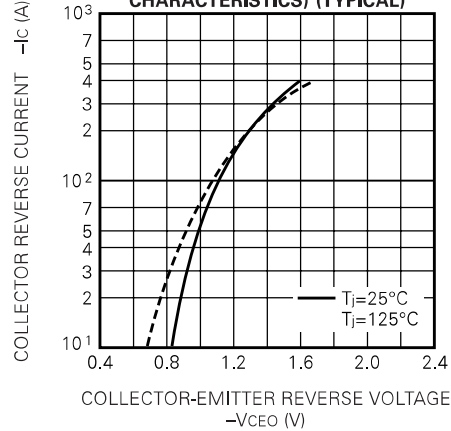

**QM200DY-HB**

**HIGH POWER SWITCHING USE  
INSULATED TYPE**

**RATED SURGE COLLECTOR REVERSE CURRENT  
(DIODE FORWARD SURGE CURRENT)**

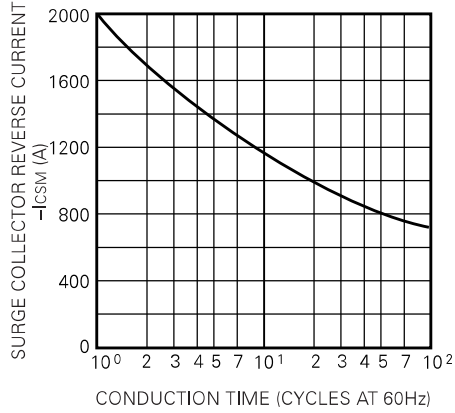

**REVERSE RECOVERY CHARACTERISTICS  
OF FREE-WHEEL DIODE (TYPICAL)**

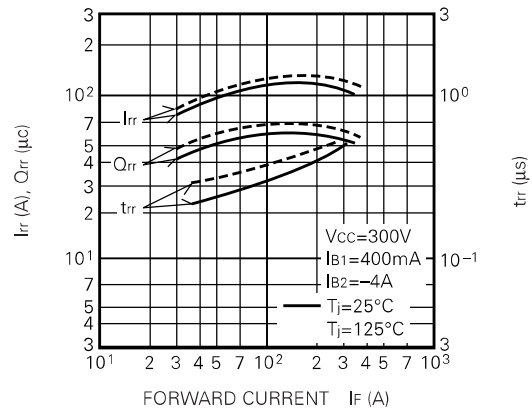

**TRANSIENT THERMAL IMPEDANCE  
CHARACTERISTIC (DIODE)**

