

MITSUBISHI FAST RECOVERY DIODE MODULES

# RM200HA-20F,-24F

HIGH SPEED SWITCHING USE  
INSULATED TYPE

RM200HA-20F,-24F



- **Idc** DC current ..... **200A**
- **VRRM** Repetitive peak reverse voltage  
..... **1000/1200V**
- **trr** Reverse recovery time ..... **0.8μs**
- **Insulated Type**
- **UL Recognized**

Yellow Card No. E80276 (N)  
File No. E80271

## APPLICATION

Free wheel use, Welders

## OUTLINE DRAWING & CIRCUIT DIAGRAM

Dimensions in mm

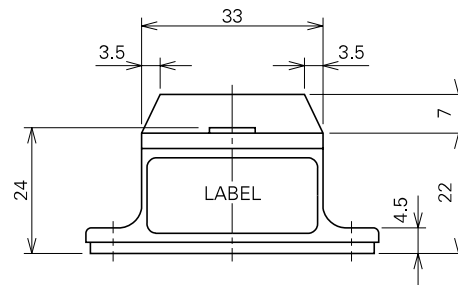
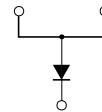
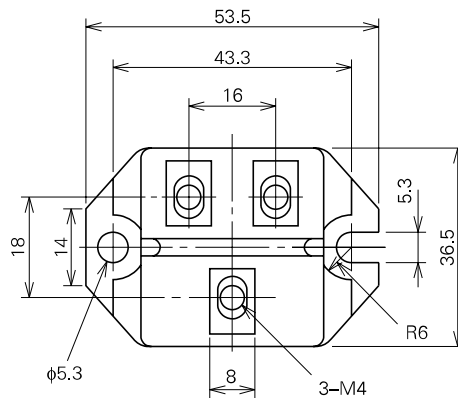

# RM200HA-20F,-24F

HIGH SPEED SWITCHING USE  
INSULATED TYPE

## ABSOLUTE MAXIMUM RATINGS (T<sub>j</sub>=25°C)

Symbol	Parameter	Voltage class		Unit
		20	24	
V <sub>RRM</sub>	Repetitive peak reverse voltage	1000	1200	V
V <sub>DRM</sub>	Non-repetitive peak reverse voltage	1100	1350	V
V <sub>R (DC)</sub>	Reverse DC voltage	800	960	V

Symbol	Parameter	Conditions	Ratings	Unit
I <sub>DC</sub>	DC output current	Resistive load, T <sub>c</sub> =75°C	200	A
I <sub>FSM</sub>	Surge (non-repetitive) forward current	One half cycle at 60Hz, peak value	4000	A
I <sup>2</sup> <sub>t</sub>	I <sup>2</sup> <sub>t</sub> for fusing	Value for one cycle of surge current	6.7 × 10 <sup>4</sup>	A <sup>2</sup> s
T <sub>j</sub>	Junction temperature		-40~150	°C
T <sub>stg</sub>	Storage temperature		-40~125	°C
V <sub>iso</sub>	Isolation voltage	Charged part to case	2500	V
—	Mounting torque	Main terminal screw M4	0.98~1.47	N·m
			10~15	kg·cm
		Mounting screw M5	1.47~1.96	N·m
			15~20	kg·cm
—	Weight	Typical value	90	g

## ELECTRICAL CHARACTERISTICS

Symbol	Parameter	Test conditions	Limits			Unit
			Min.	Typ.	Max.	
I <sub>RRM</sub>	Repetitive reverse current	T <sub>j</sub> =150°C, V <sub>RRM</sub> applied	—	—	40	mA
V <sub>FM</sub>	Forward voltage	T <sub>j</sub> =25°C, I <sub>FM</sub> =200A, instantaneous meas.	—	—	1.5	V
t <sub>rr</sub>	Reverse recovery time	I <sub>FM</sub> =200A, di/dt=-400A/μs, V <sub>R</sub> =600V, T <sub>j</sub> =150°C	—	—	0.8	μs
Q <sub>rr</sub>	Reverse recovery charge		—	—	130	μC
R <sub>th (j-c)</sub>	Thermal resistance	Junction to case	—	—	0.25	°C/W
R <sub>th (c-f)</sub>	Contact thermal resistance	Case to fin, conductive grease applied	—	—	0.15	°C/W

# RM200HA-20F,-24F

HIGH SPEED SWITCHING USE  
INSULATED TYPE

## PERFORMANCE CURVE

**MAXIMUM FORWARD CHARACTERISTIC**

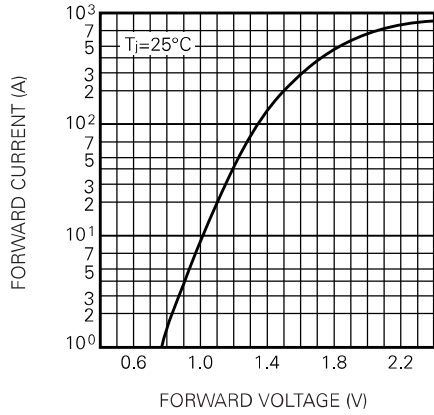

**MAXIMUM TRANSIENT THERMAL IMPEDANCE (JUNCTION TO CASE)**

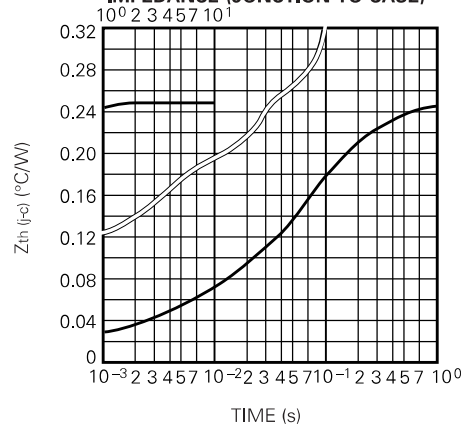

**RATED SURGE (NON-REPETITIVE) FORWARD CURRENT**

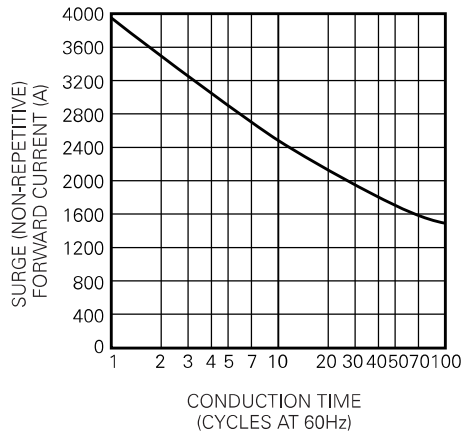

**REVERSE RECOVERY CHARACTERISTICS VS. FORWARD CURRENT (TYPICAL)**

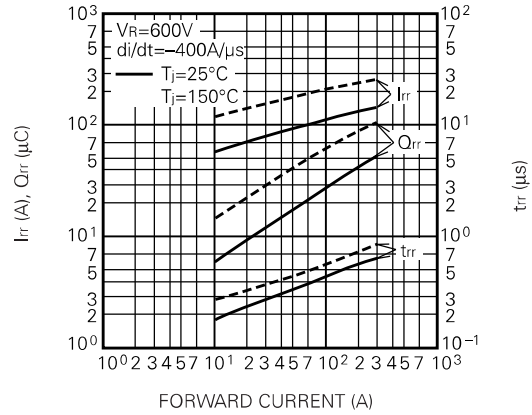

**REVERSE RECOVERY CHARACTERISTICS VS. -di/dt (TYPICAL)**

